

## TABLE OF CONTENT

No.	Title
MT-SYN-380-01	Power
MT-SYN-380-02	3Ø380VAC
MT-SYN-380-03	1Ø220VAC
MT-SYN-380-04	1Ø110VAC-1
MT-SYN-380-04-01	1Ø110VAC-2
MT-SYN-380-05	24VDC (24/0)
MT-SYN-380-05-01	24VDC (24V1/0V1)
MT-SYN-380-05-02	24VDC (149/151)
MT-SYN-380-06	Controller and Operation pannel
MT-SYN-380-07	24 PIN - Barloader Interface
MT-SYN-380-08	Input Interface
MT-SYN-380-09	Output Interface
MT-SYN-380-10	S08-SMD-33B

NOTE

Model	MT		
Spec.	SYNTEC		
Design		Date	
Draw	JH	Date	20191110
Check		Date	



光鉛企業股份有限公司  
KEEN CHIEF CO., LTD.

Title	Table of Content
No.	MT-SYN-380-Index

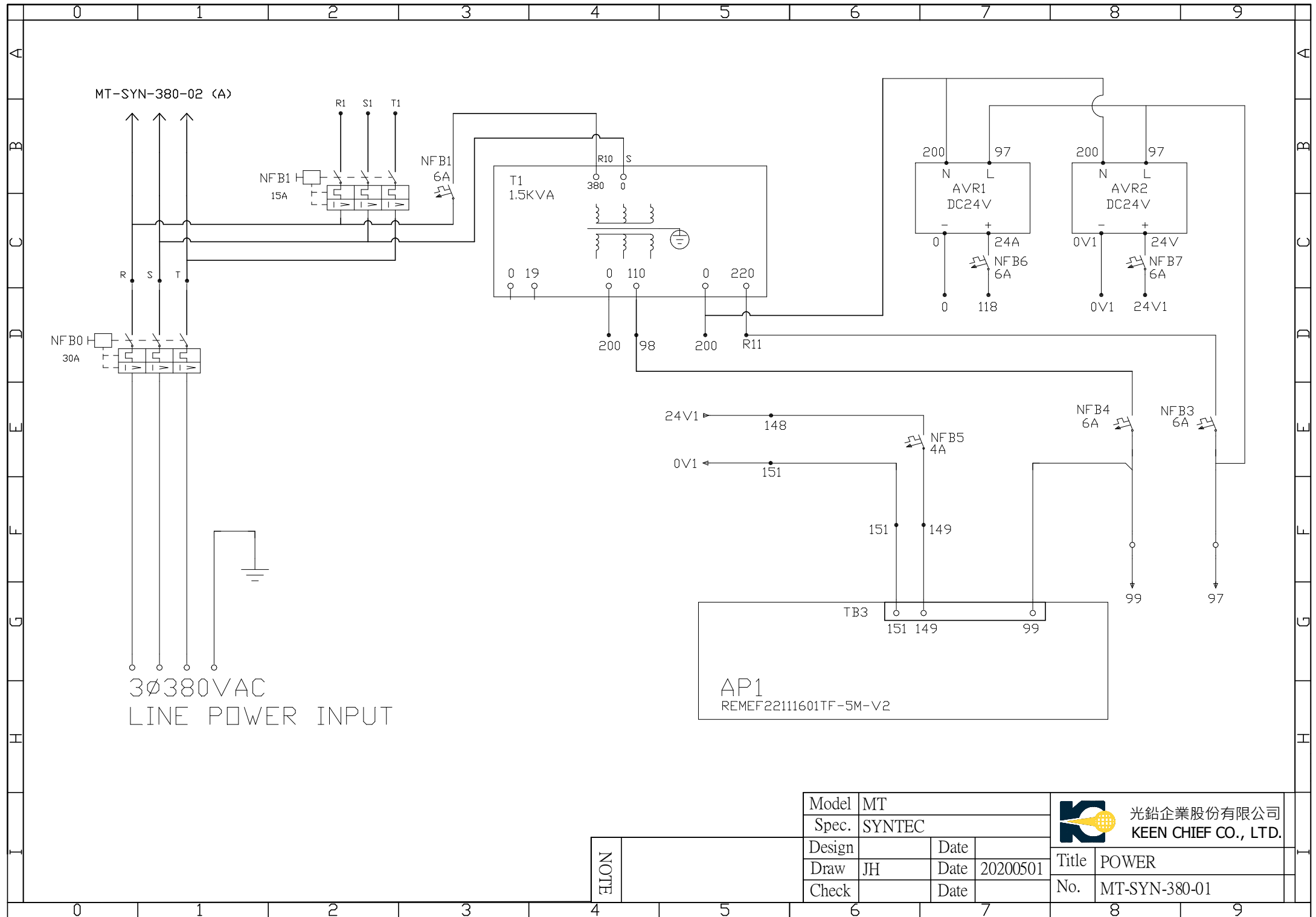

MT-SYN-380-02 (A)

3Ø380VAC  
LINE POWER INPUT

AP1  
REMEF22111601TF-5M-V2

Model	MT		
Spec.	SYNTEC		
Design		Date	
Draw	JH	Date	20200501
Check		Date	

 光鉛企業股份有限公司 KEEN CHIEF CO., LTD.	Title	POWER
	No.	MT-SYN-380-01

NOTE

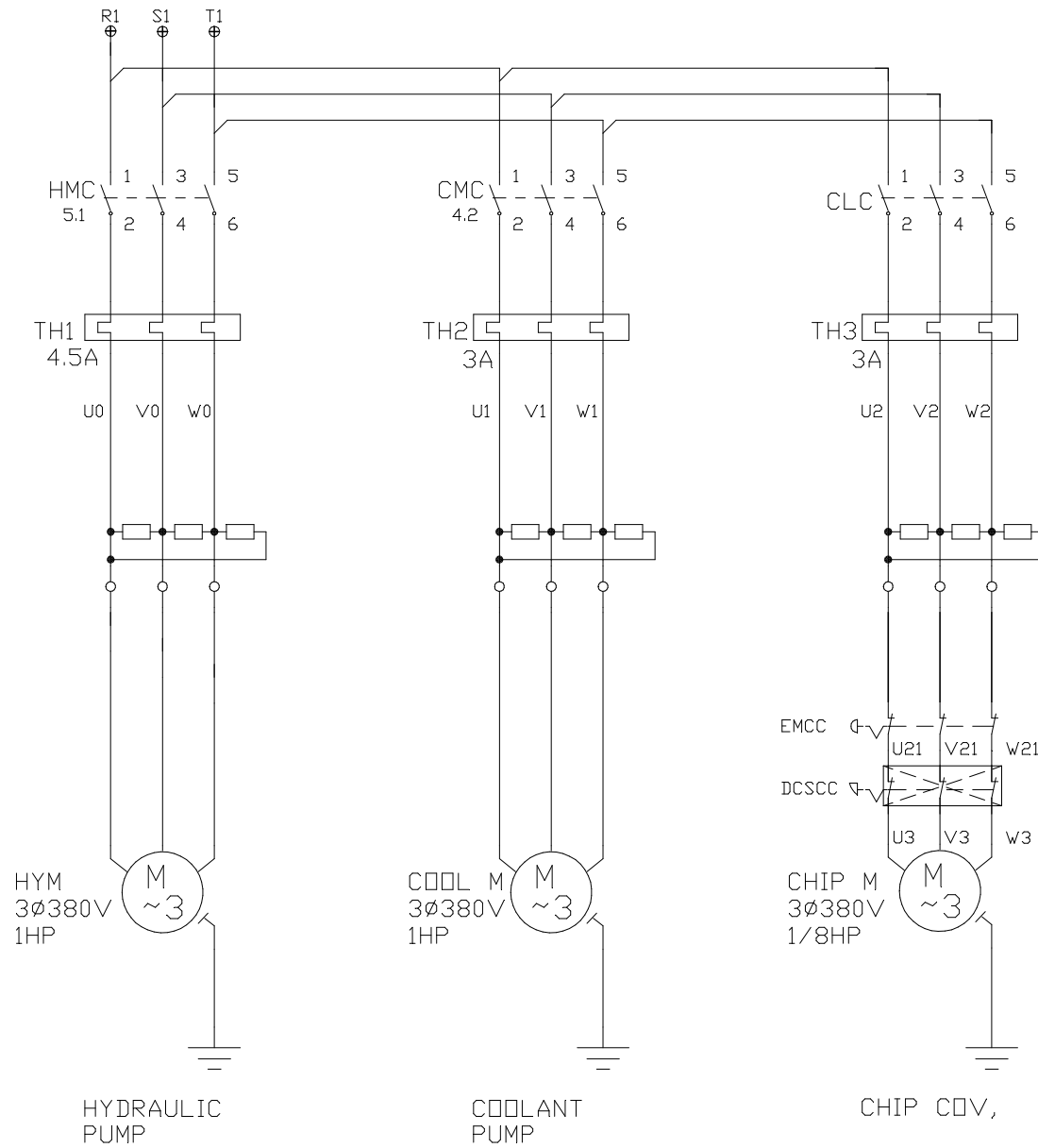

NOTE

Model	MT		
Spec.	SYNTEC		
Design		Date	
Draw	JH	Date	20200501
Check		Date	

 光鉛企業股份有限公司 KEEN CHIEF CO., LTD.	Title	3Ø380V
	No.	MT-SYN-380-02

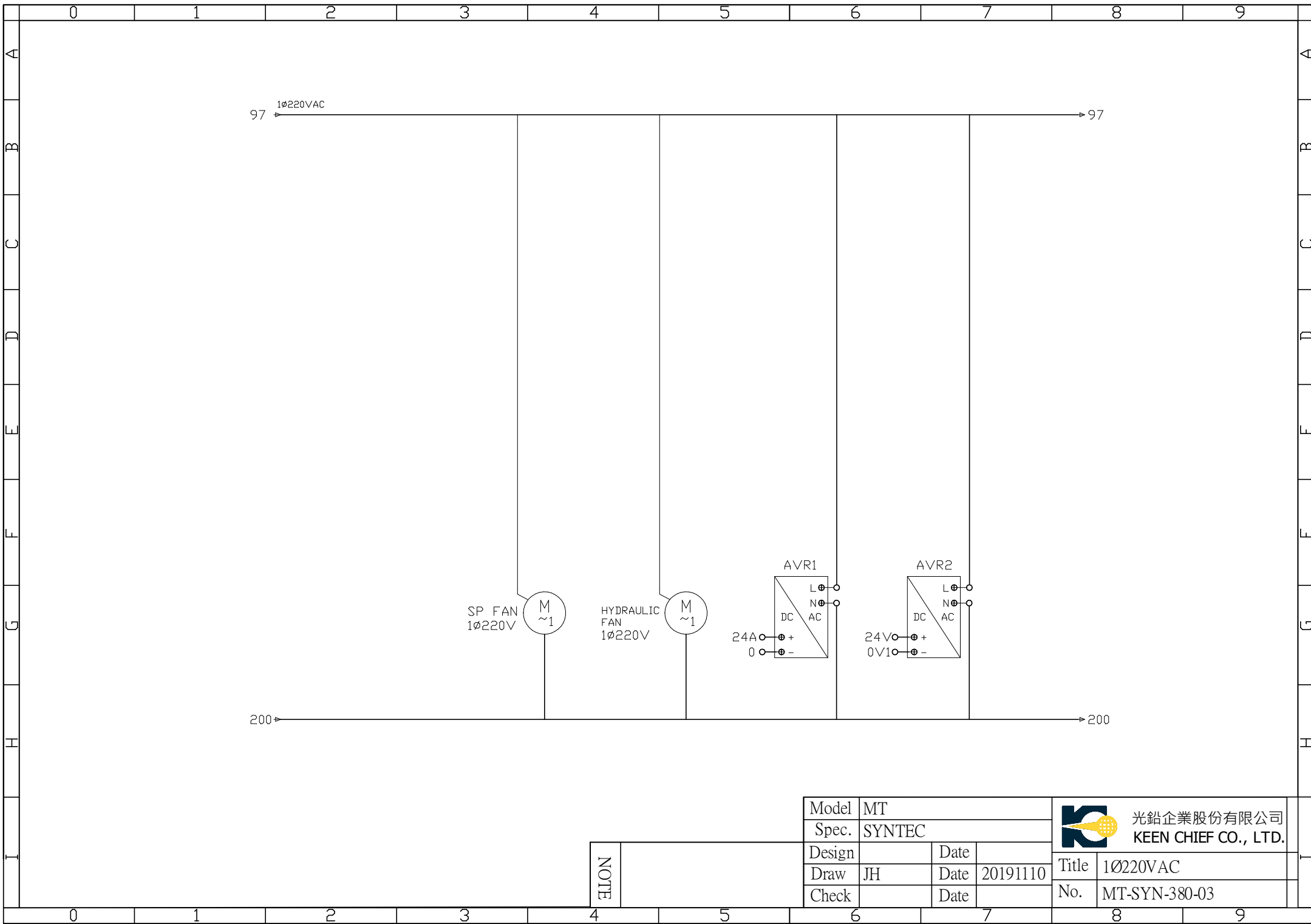

NOTE

Model	MT		
Spec.	SYNTEC		
Design		Date	
Draw	JH	Date	20191110
Check		Date	



光鉛企業股份有限公司  
KEEN CHIEF CO., LTD.

Title	1Ø220VAC		
No.	MT-SYN-380-03		

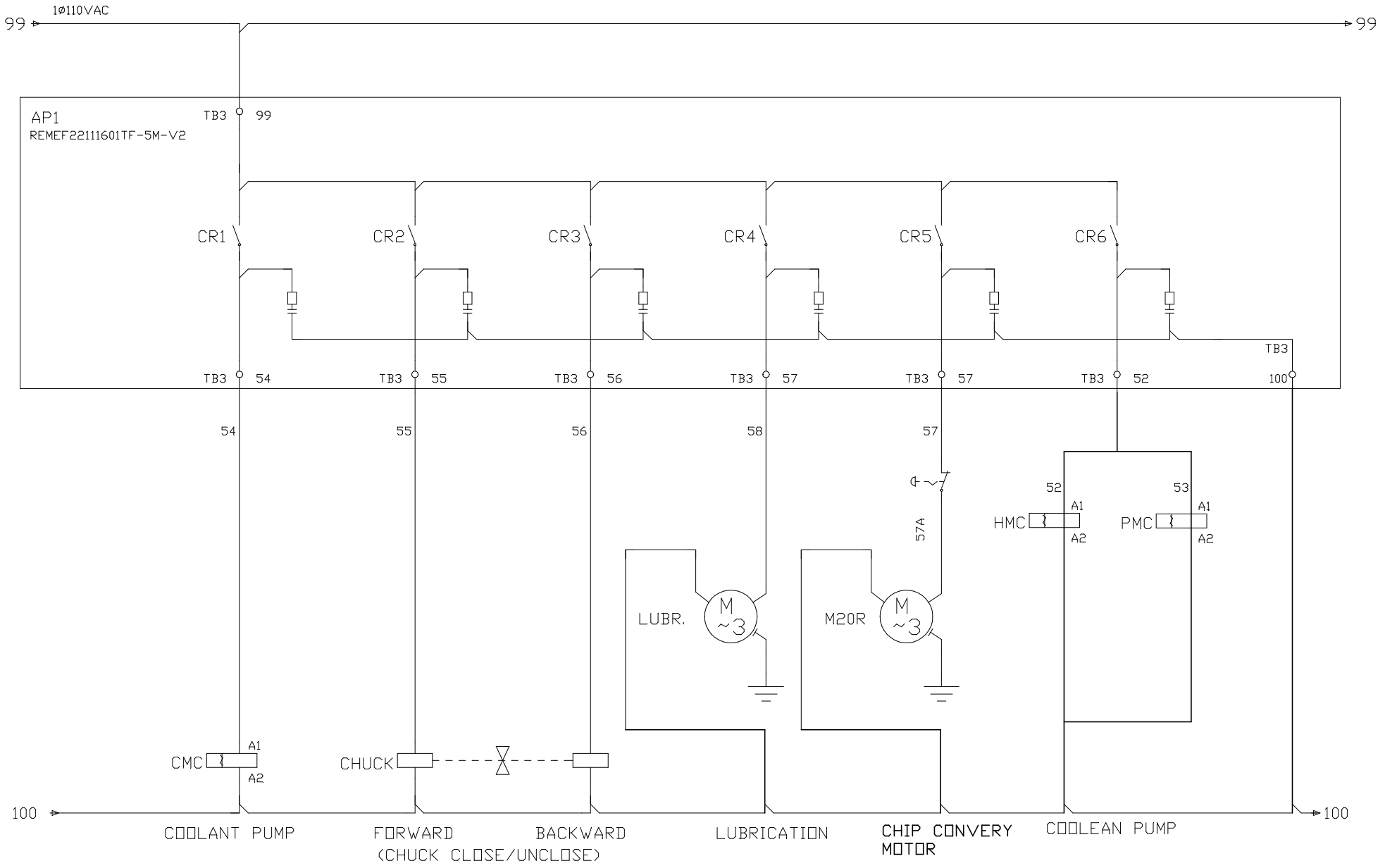

COOLANT PUMP

FORWARD  
CHUCK CLOSE/UNCLOSE

BACKWARD

LUBRICATION

CHIP CONVEY  
MOTOR

COOLEAN PUMP

NOTE

Model	MT		
Spec.	SYNTEC		
Design		Date	
Draw	JH	Date	20200501
Check		Date	



光鉛企業股份有限公司  
KEEN CHIEF CO., LTD.

Title	1Ø110VAC
No.	MT-SYN-380-04

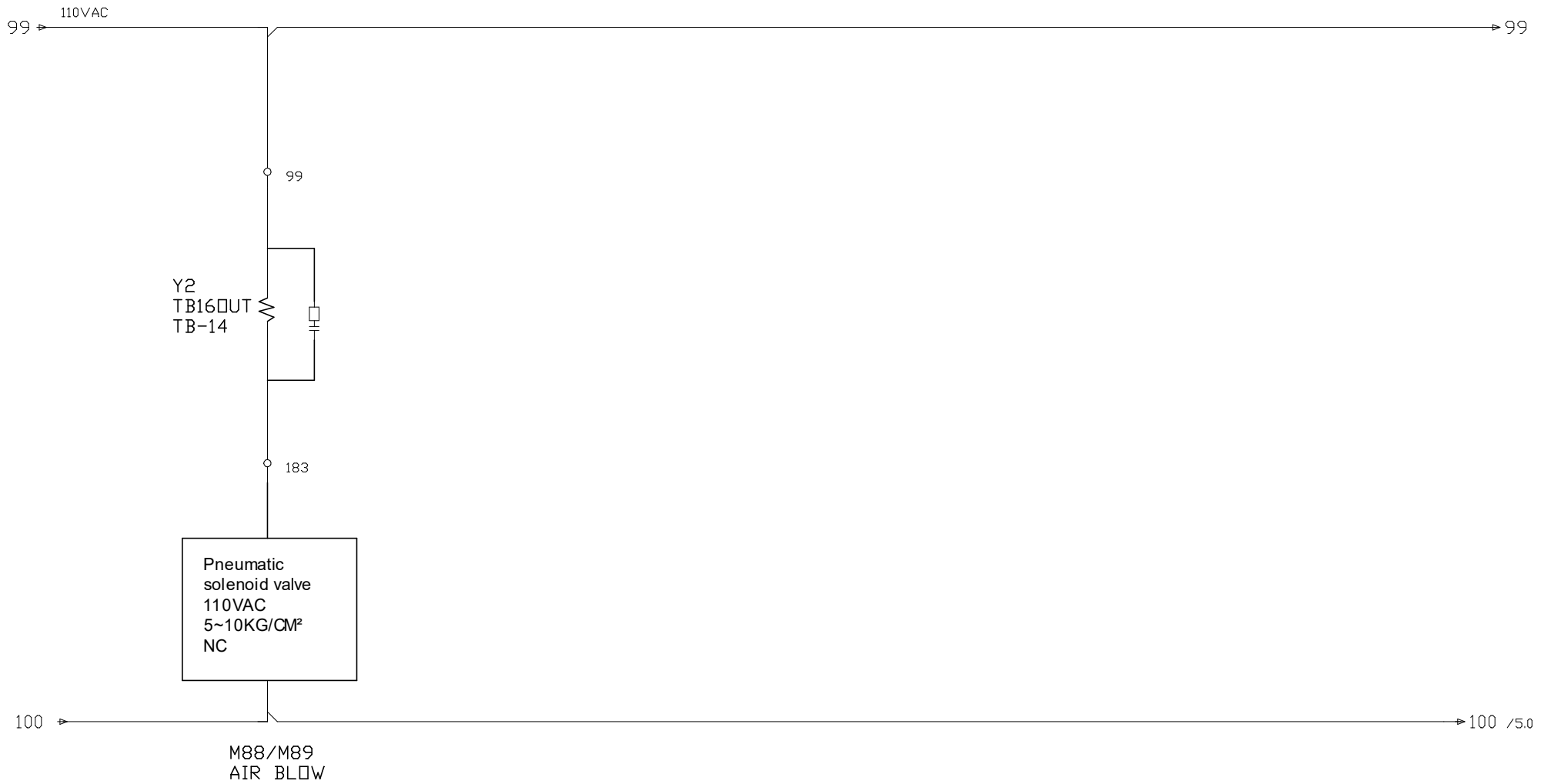

NOTE

Model	MT		
Spec.	SYNTEC		
Design		Date	
Draw	JH	Date	20200501
Check		Date	



光鉛企業股份有限公司  
KEEN CHIEF CO., LTD.

Title	1Ø110VAC
No.	MT-SYN-380-04-01

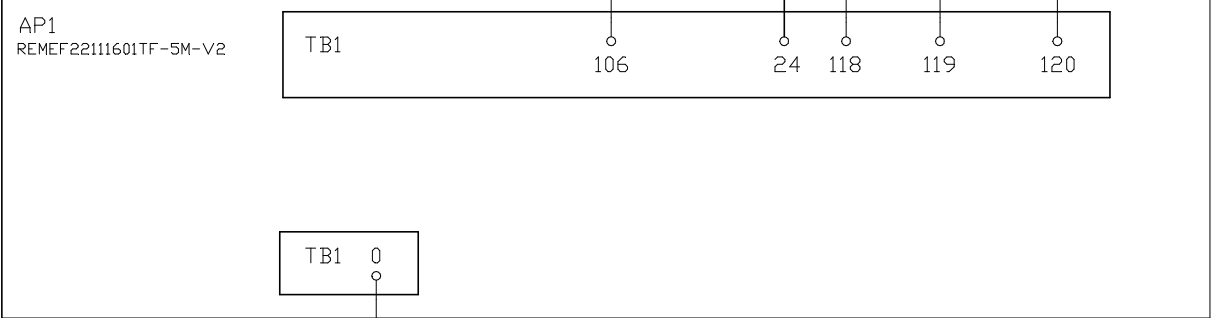
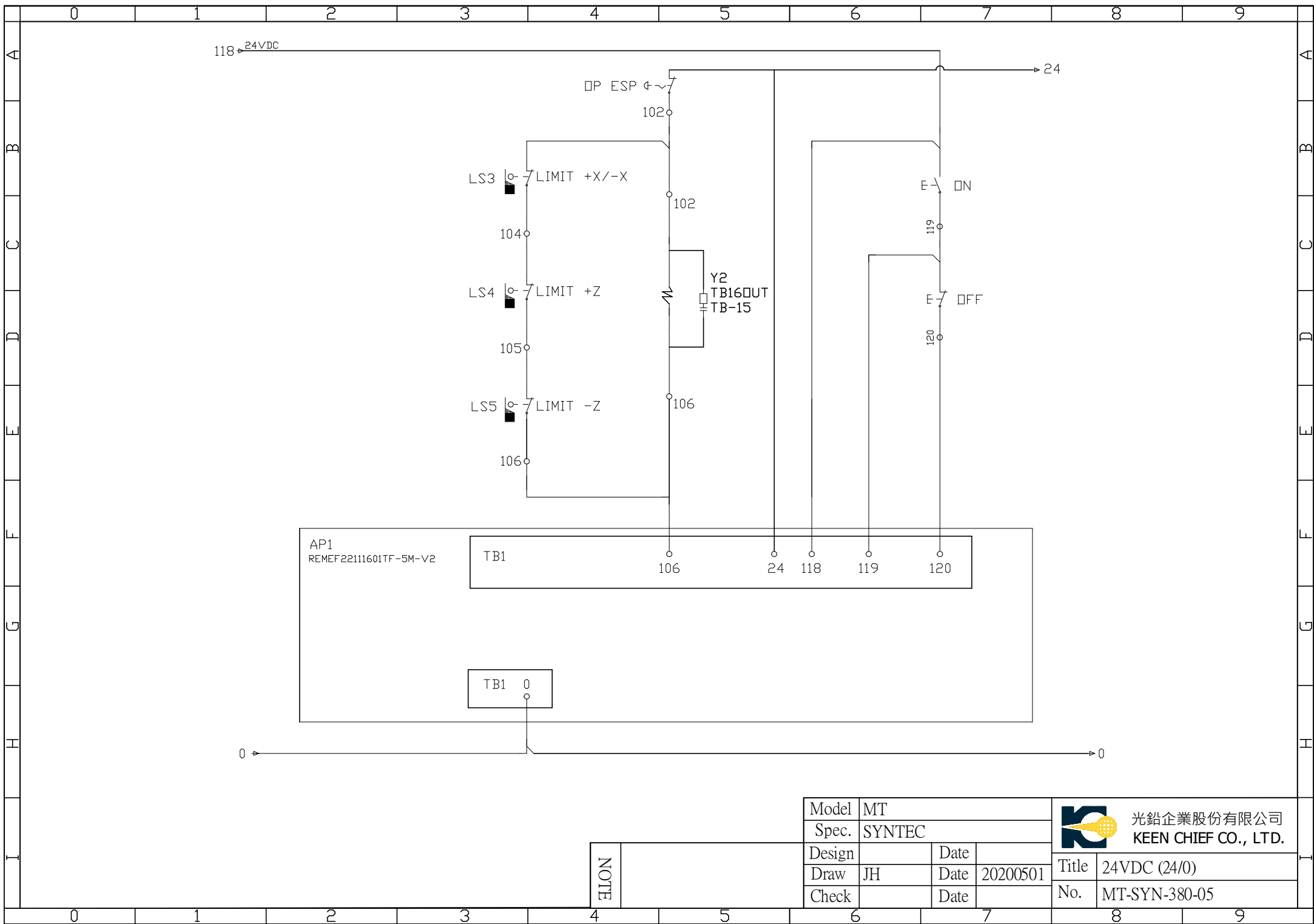

NOTE

Model	MT		
Spec.	SYNTEC		
Design		Date	
Draw	JH	Date	20200501
Check		Date	



光鉛企業股份有限公司  
KEEN CHIEF CO., LTD.

Title	24VDC (24/0)
No.	MT-SYN-380-05

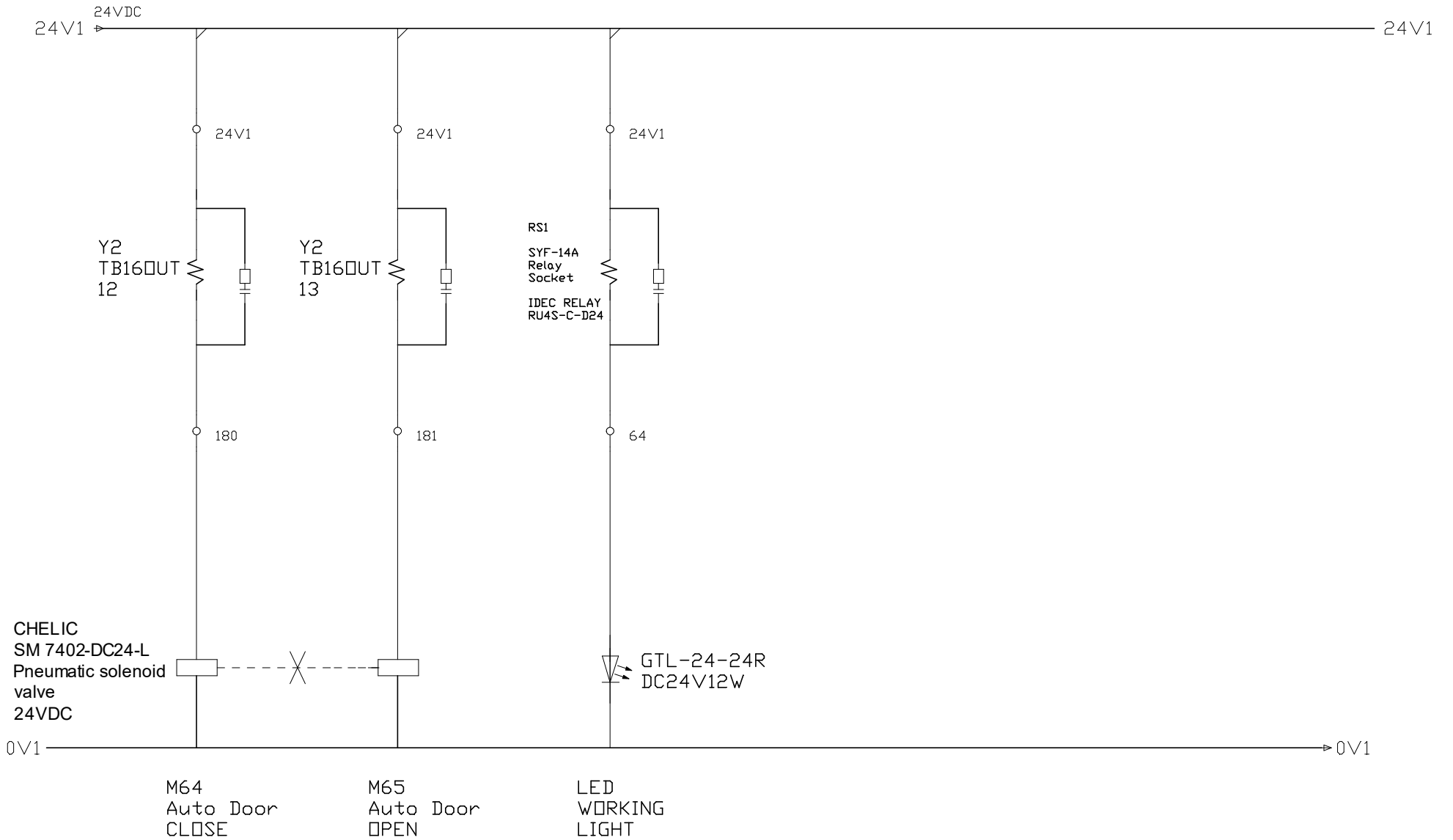

NOTE

Model	MT		
Spec.	SYNTEC		
Design		Date	
Draw	JH	Date	20200501
Check		Date	



Title	24VDC (24V1/0V1)
No.	MT-SYN-380-05-01



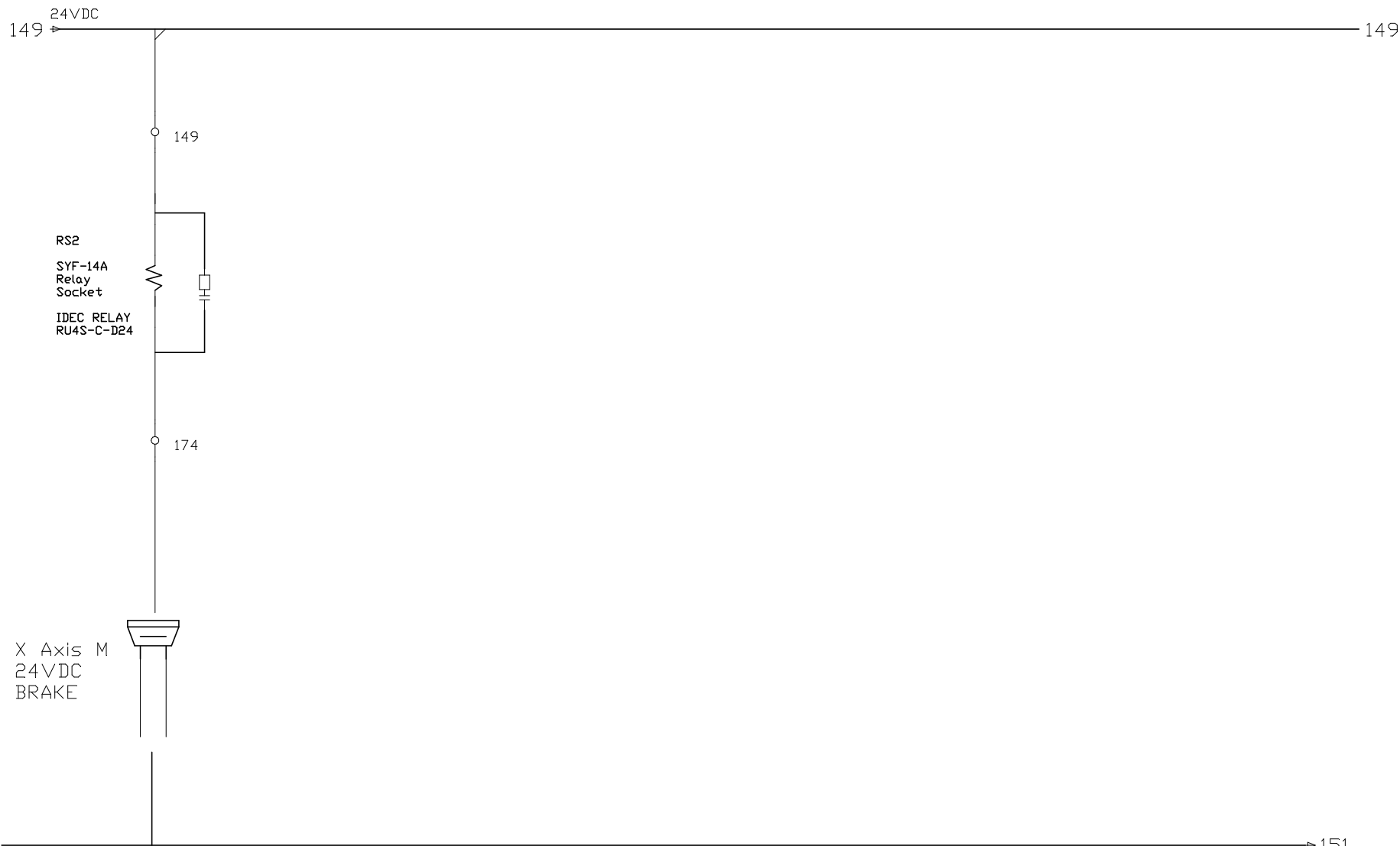

RS2  
SYF-14A  
Relay  
Socket  
IDEC RELAY  
RU4S-C-D24

X Axis M  
24VDC  
BRAKE

X AXIS BRAKE  
24VDC

NOTE

Model	MT		
Spec.	SYNTEC		
Design		Date	
Draw		Date	20200501
Check		Date	



光鉛企業股份有限公司  
KEEN CHIEF CO., LTD.

Title	24VDC (149/151)
No.	MT-SYN-380-05-02

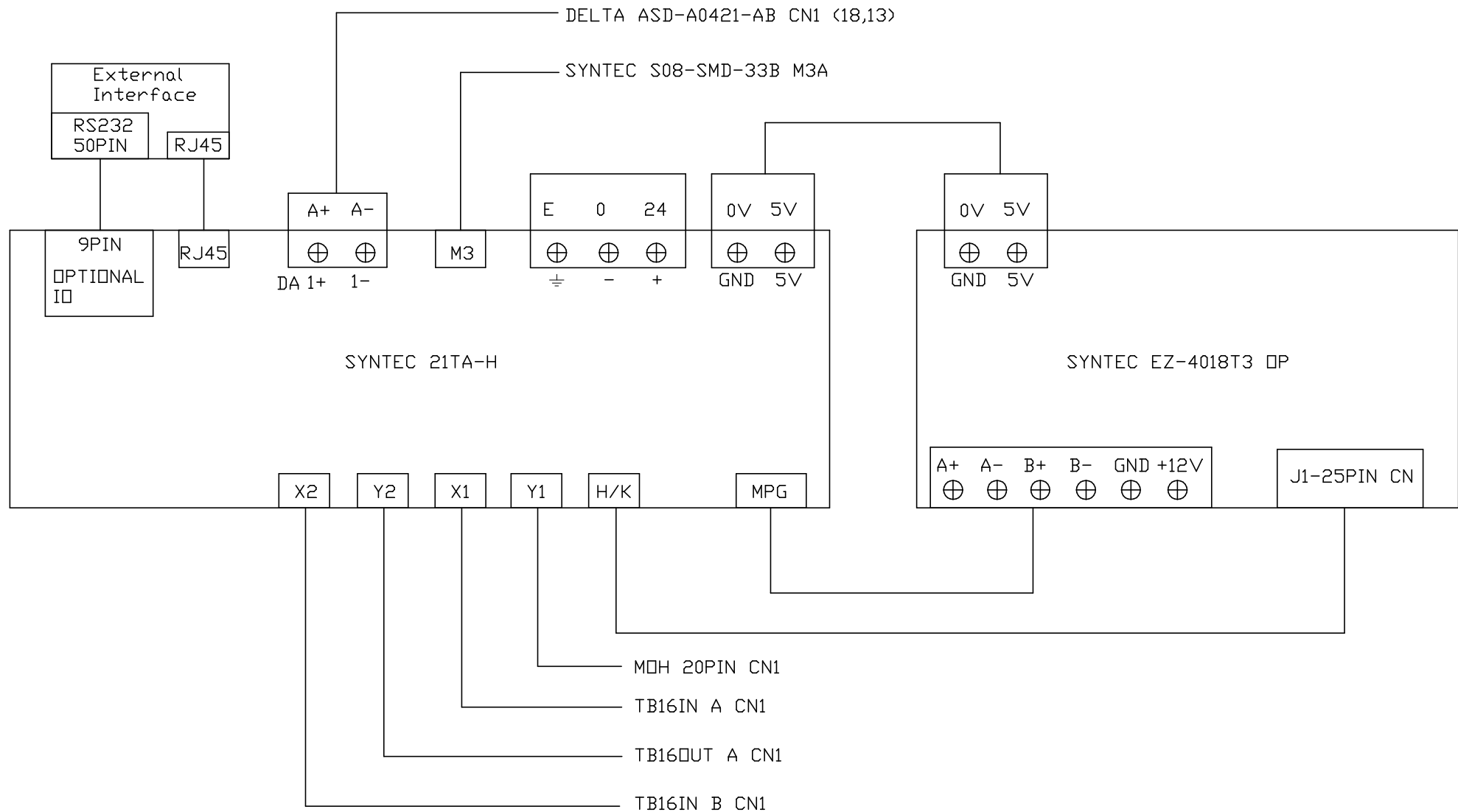

NOTE

Model	MT		
Spec.	SYNTEC		
Design		Date	
Draw	JH	Date	20191124
Check		Date	



光鉛企業股份有限公司  
KEEN CHIEF CO., LTD.

Title	Controller & OP		
No.	MT-SYN-380-06		

24 PIN INTERFACE

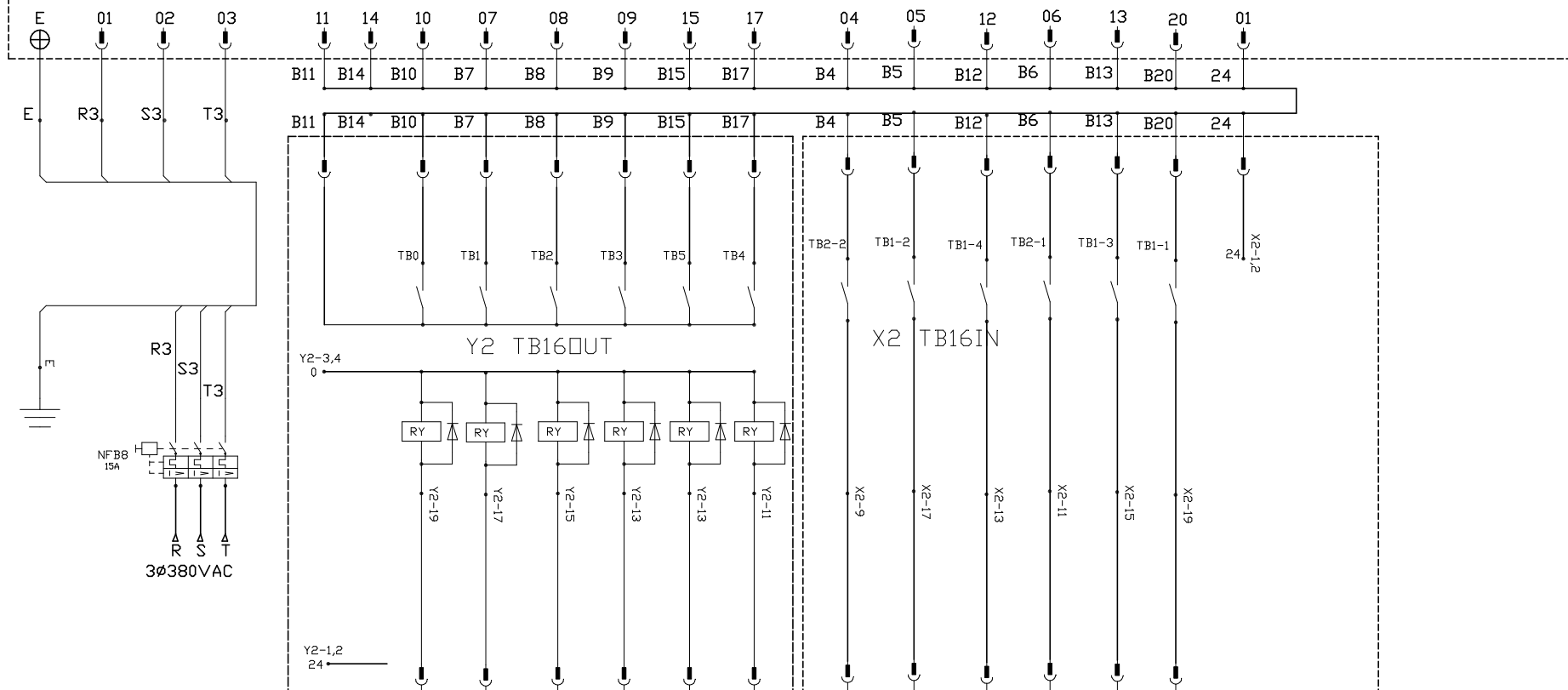

- D21 Not used
- D20 CNC AUTO MODE
- D19 CNC Alarm
- D18 M31 Relay Barfeeder Start
- D17 SP. CHUCK UNCLAMP READY
- D16 M94 Back start
- I16 Barloader start
- I17 Barloader End
- I18 Barloader Alarm Signal
- I19 Barloader Inch Mode
- I20 Barloader Auto Mode
- I21 Barloader In Work

NOTE

Model	MT		
Spec.	SYNTEC		
Design		Date	
Draw	JH	Date	20191124
Check		Date	

 光鉛企業股份有限公司 KEEN CHIEF CO., LTD.	Title	24 PIN-Barloader Interface
	No.	MT-SYN-380-07

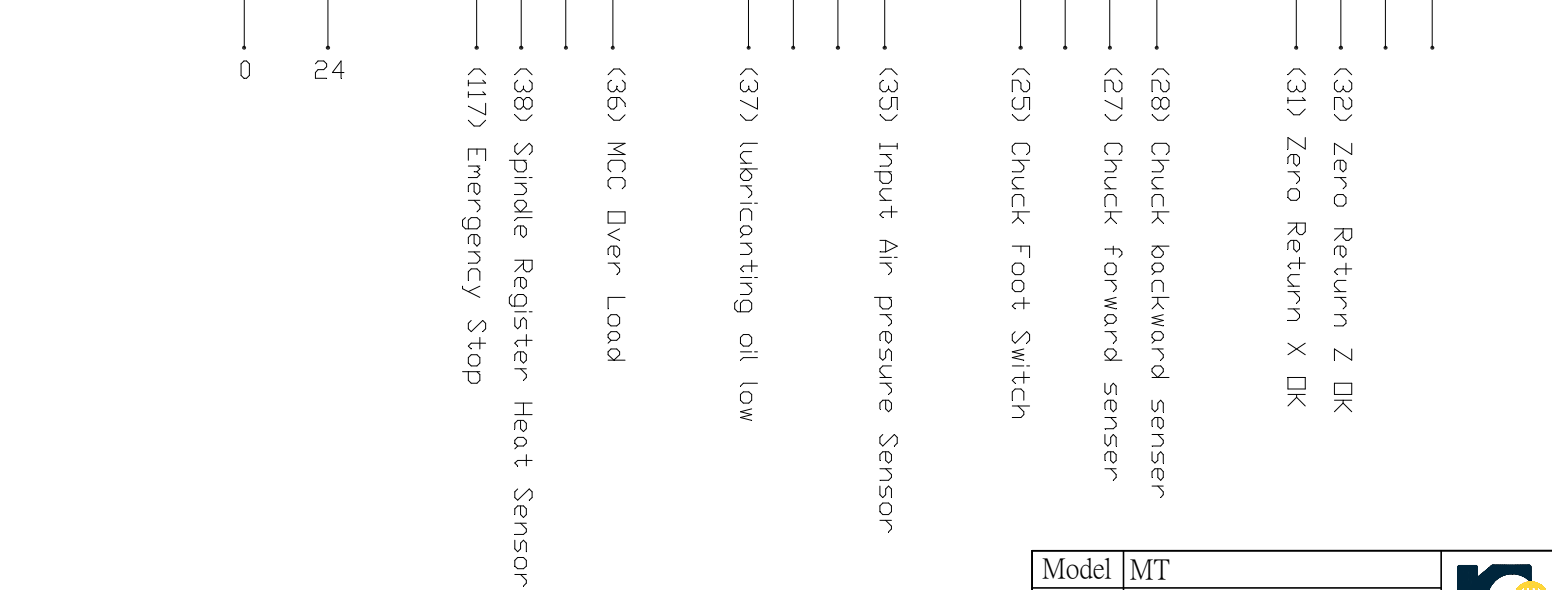
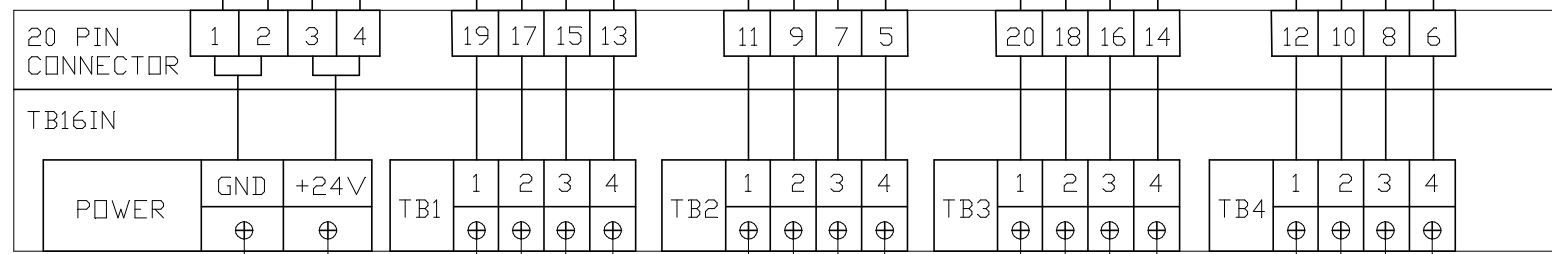
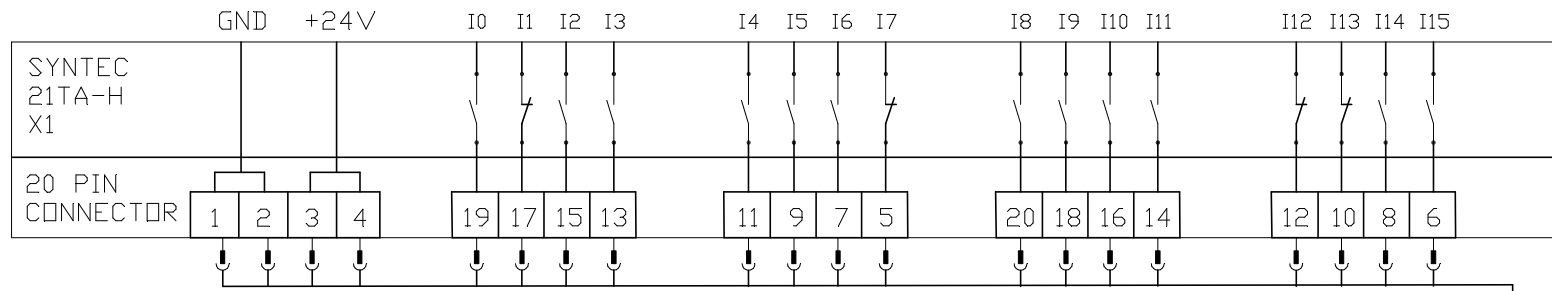

NOTE

Model	MT		
Spec.	SYNTEC		
Design		Date	
Draw	JH	Date	20200501
Check		Date	

光鉛企業股份有限公司  
KEEN CHIEF CO., LTD.

Title	INPUT - X1
No.	MT-SYN-380-08

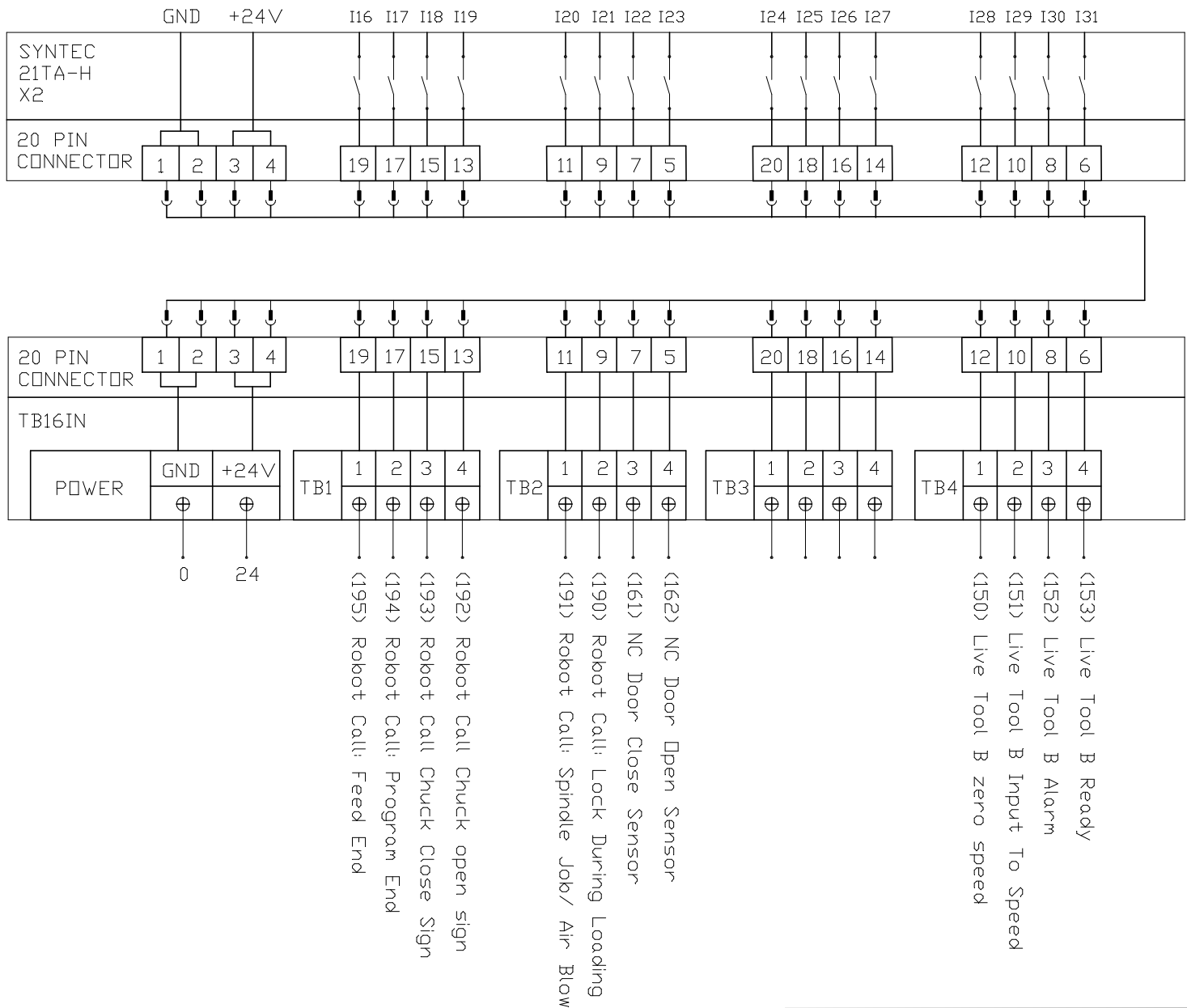

NOTE

Model	MT		
Spec.	SYNTEC		
Design		Date	
Draw	JH	Date	20200501
Check		Date	

光鉛企業股份有限公司  
KEEN CHIEF CO., LTD.

Title	INPUT - X2
No.	MT-SYN-380-08-1

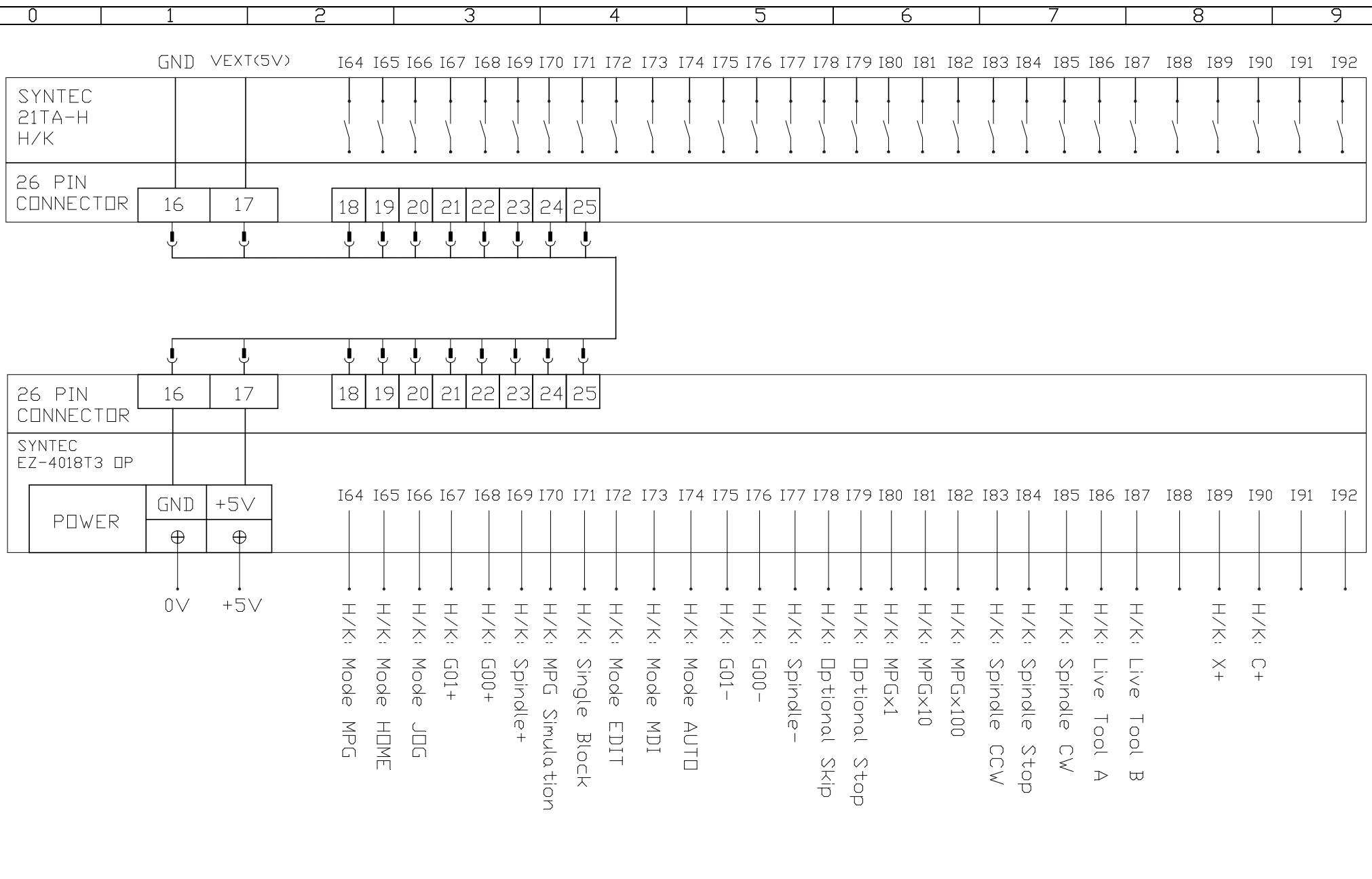

Model	MT		
Spec.	SYNTEC		
Design		Date	
Draw	JAY HSU	Date	20200501
Check		Date	



Title	INPUT - OP
No.	MT-SYN-380-08-2

NOTE

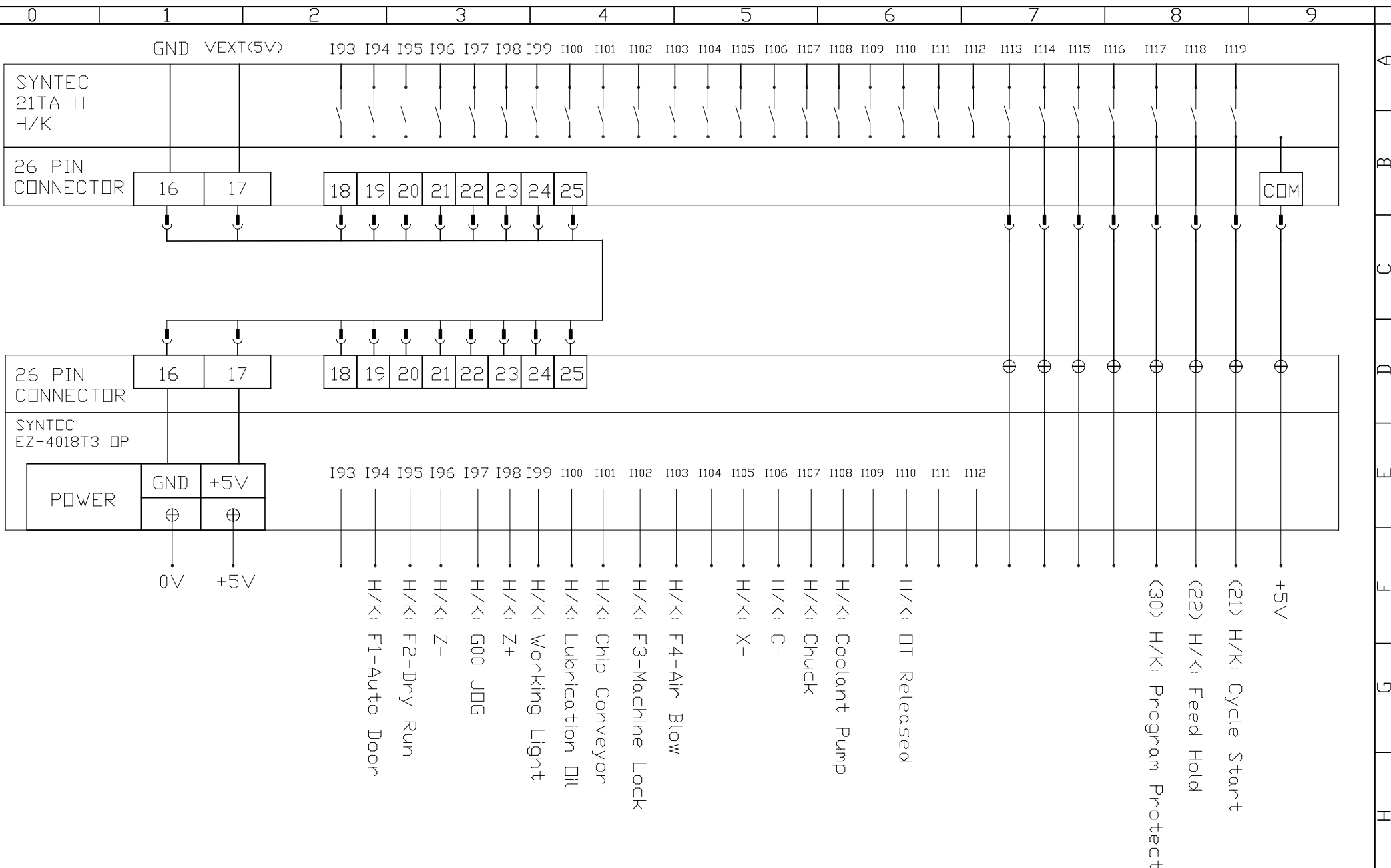

Model	MT		
Spec.	SYNTEC		
Design		Date	
Draw	JAY HSU	Date	20200501
Check		Date	



光鉛企業股份有限公司  
KEEN CHIEF CO., LTD.

Title	INPUT - OP
No.	MT-SYN-380-08-3

NOTE

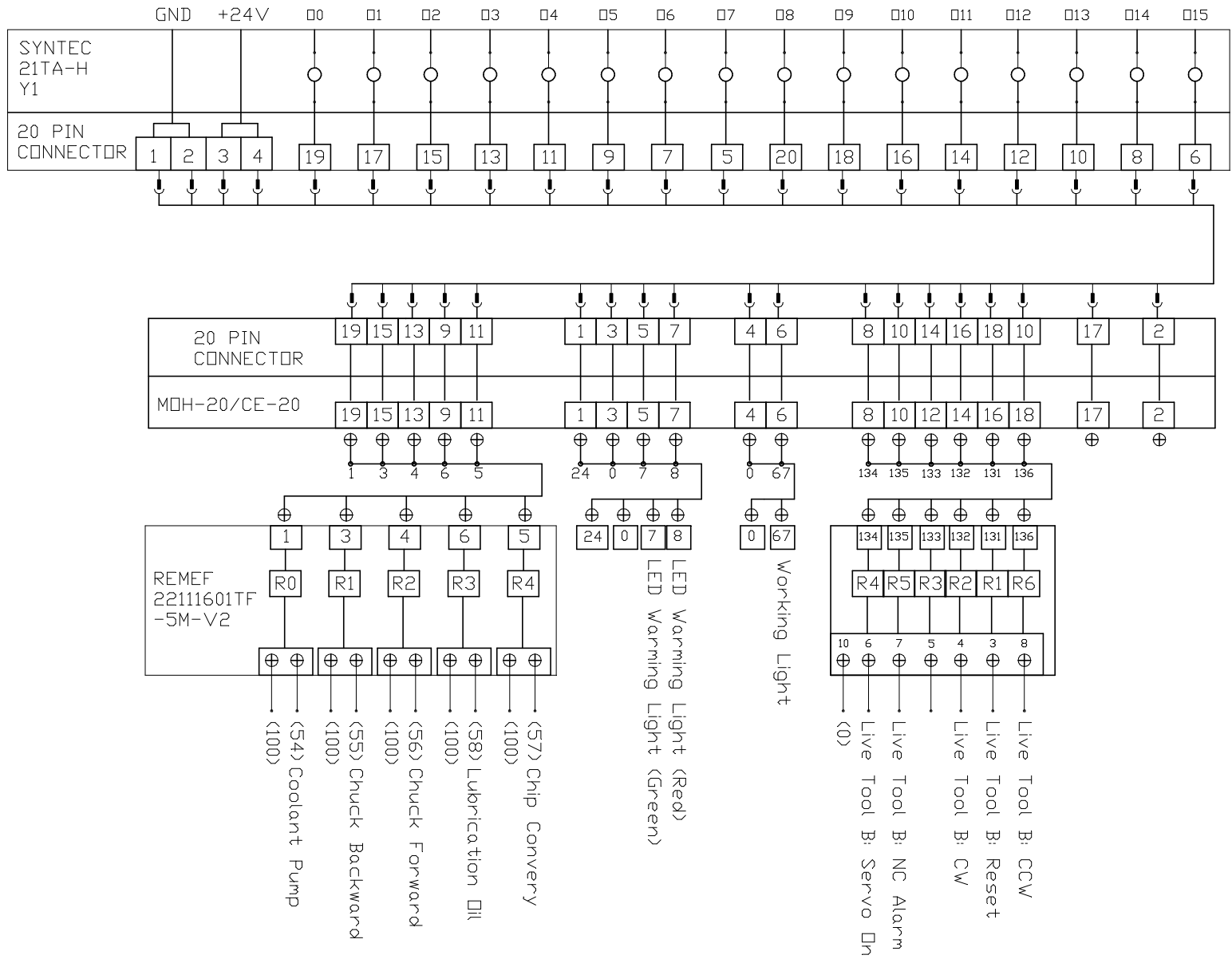

NOTE

Model	MT		
Spec.	SYNTEC		
Design		Date	
Draw	JAY HSU	Date	20200501
Check		Date	



光鉛企業股份有限公司  
KEEN CHIEF CO., LTD.

Title	OUTPUT - Y1
No.	MT-SYN-380-09



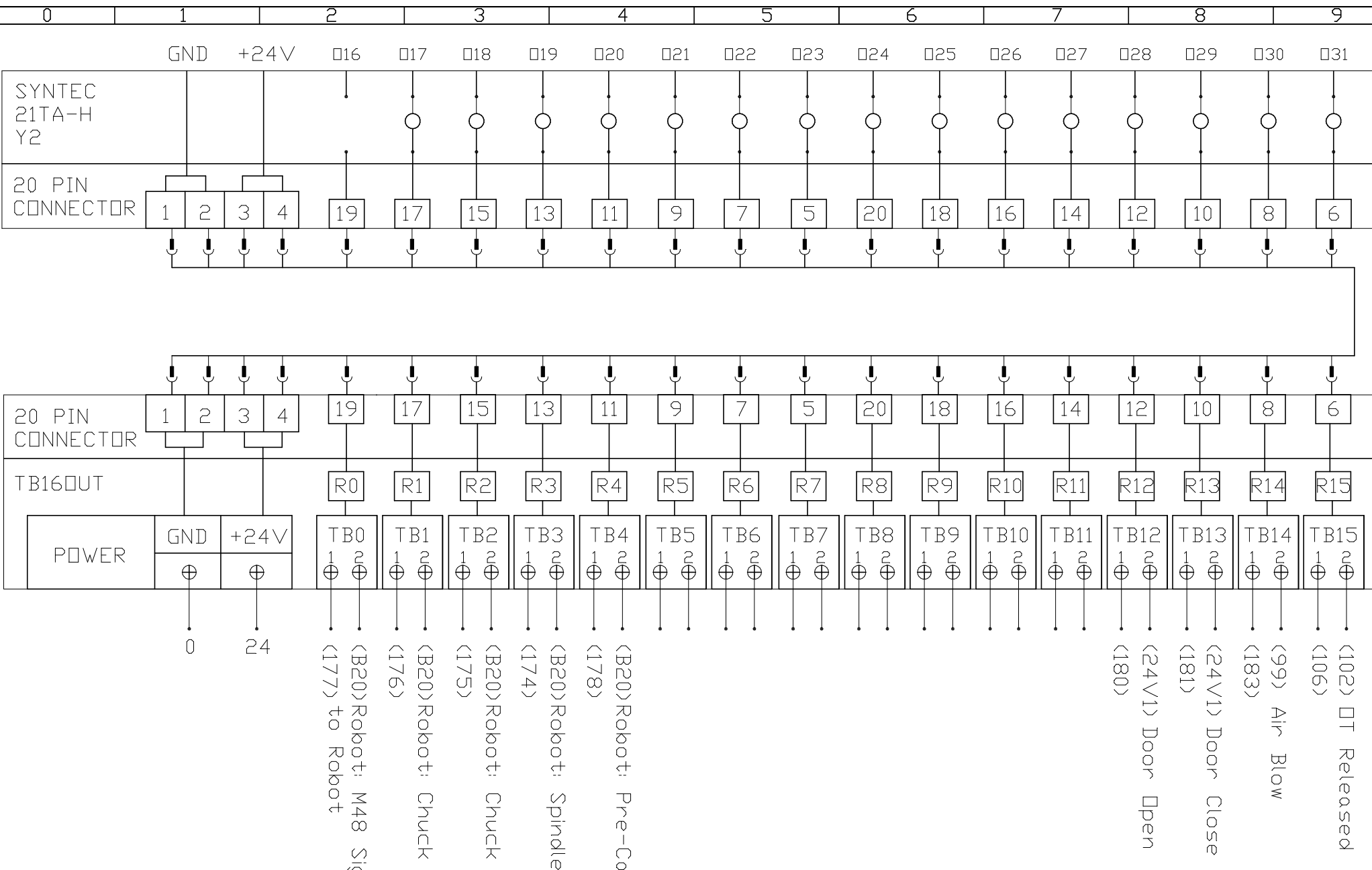

Model	MT		
Spec.	SYNTEC		
Design		Date	
Draw	JAY HSU	Date	20200501
Check		Date	



光鉛企業股份有限公司  
KEEN CHIEF CO., LTD.

Title	OUTPUT-Y2
No.	MT-SYN-380-09-1

NOTE

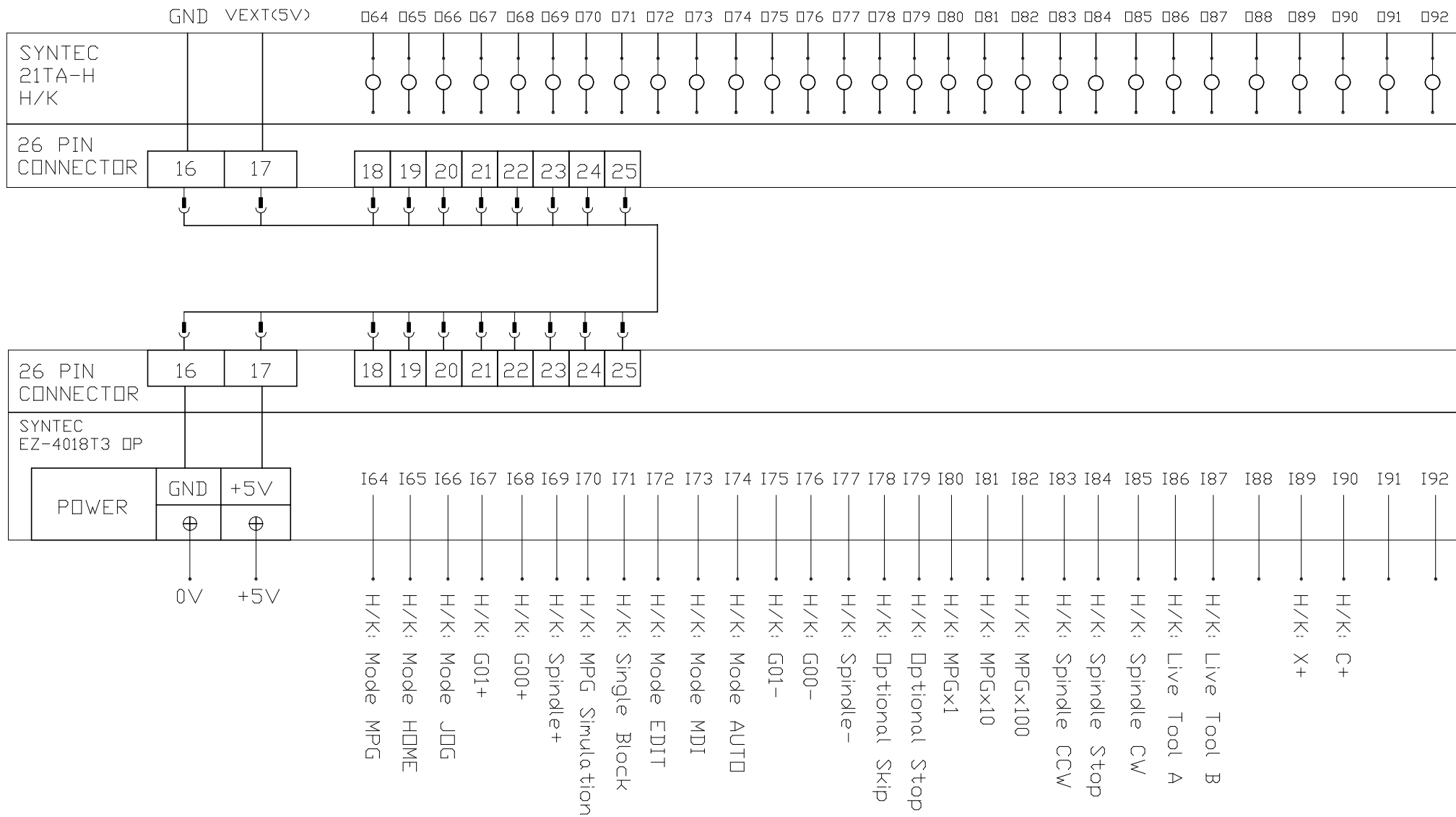

NOTE

Model	MT		
Spec.	SYNTEC		
Design		Date	
Draw	JAY HSU	Date	20200501
Check		Date	



光鉛企業股份有限公司  
KEEN CHIEF CO., LTD.

Title	OUTPUT-OP
No.	MT-SYN-380-09-2

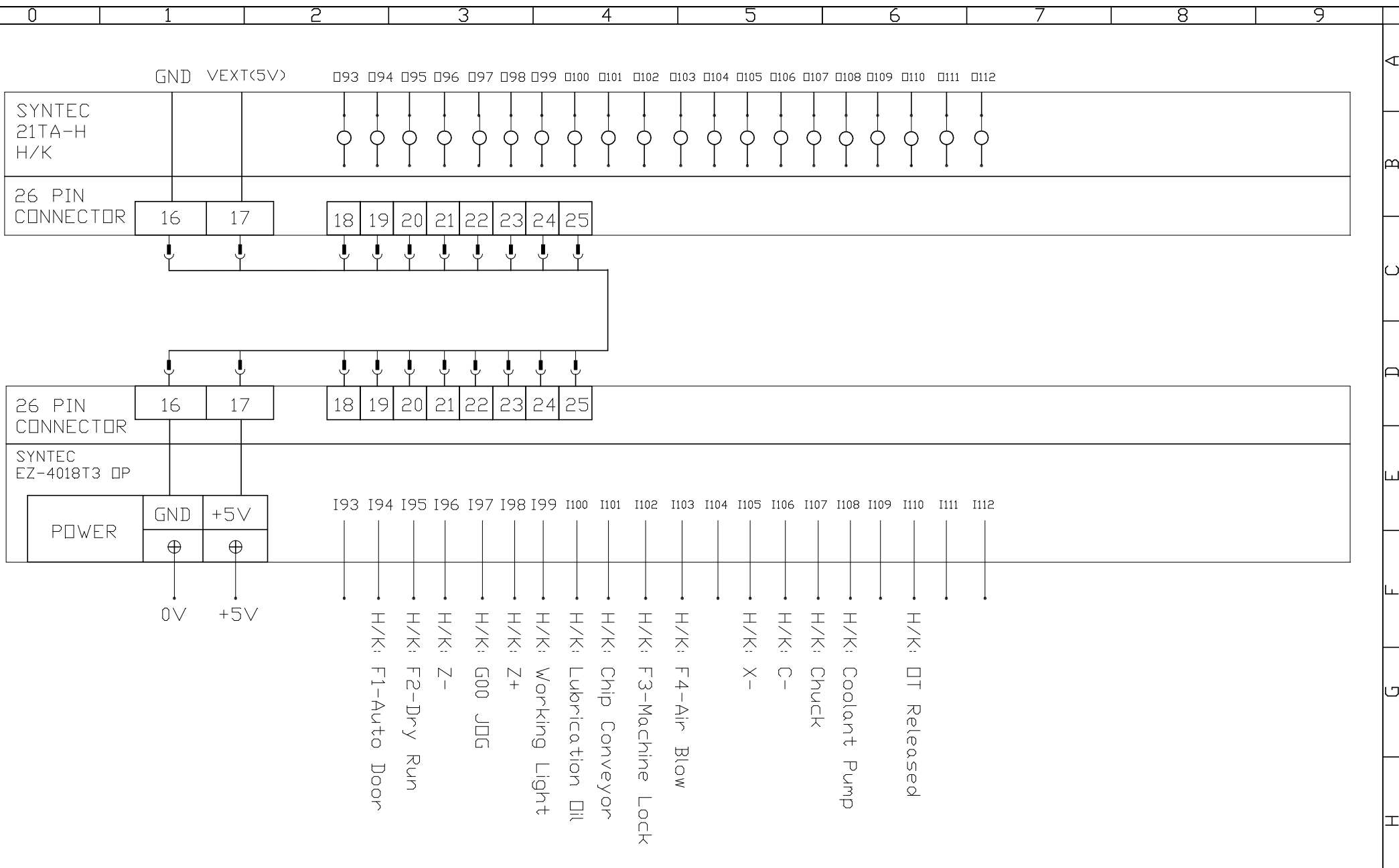

Model	MT		
Spec.	SYNTEC		
Design		Date	
Draw	JAY HSU	Date	20200501
Check		Date	



光鉛企業股份有限公司  
KEEN CHIEF CO., LTD.

Title	OUTPUT-OP
No.	MT-SYN-380-09-3

NOTE

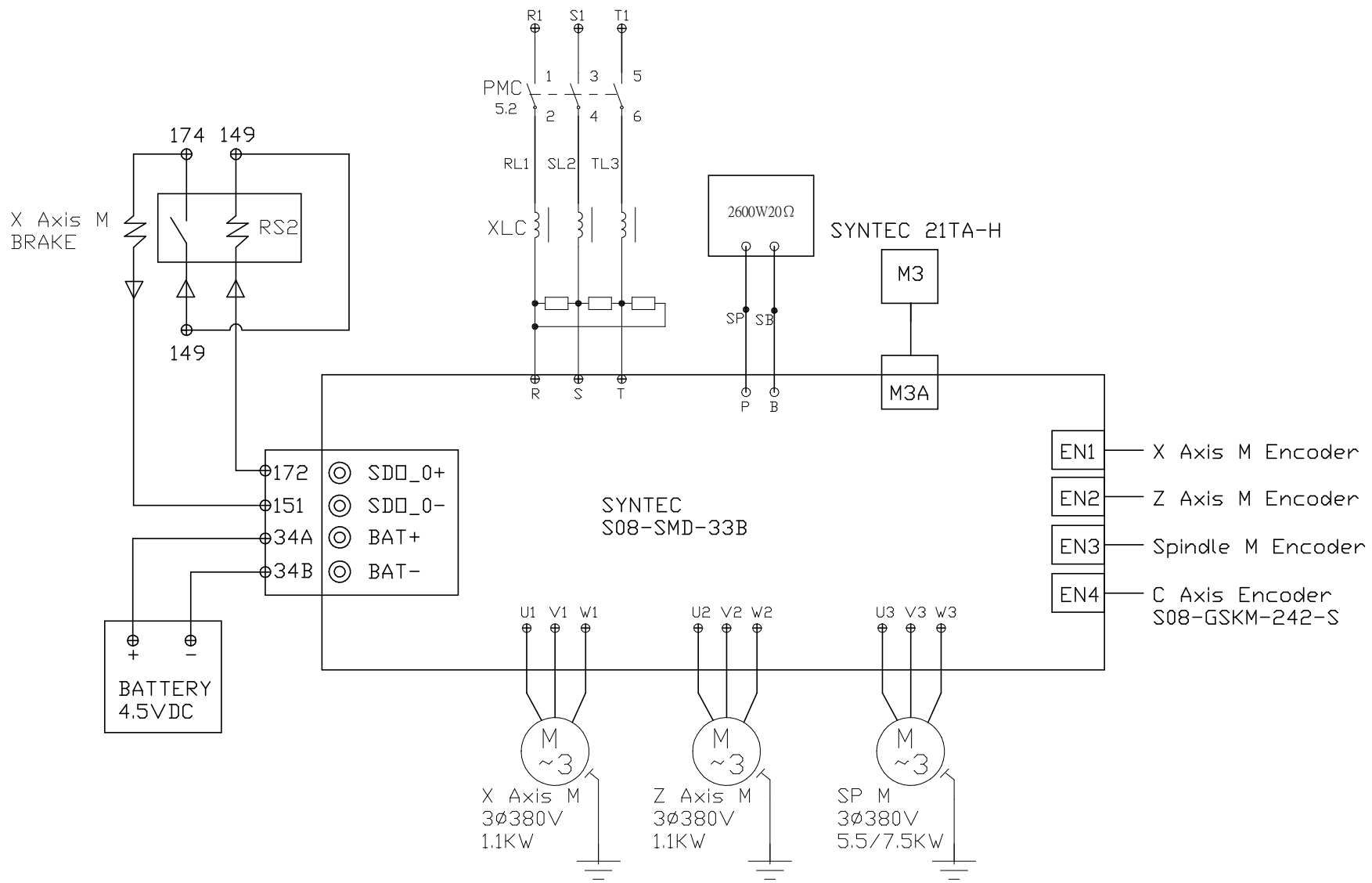

NOTE

Model	MT		
Spec.	SYNTEC		
Design		Date	
Draw	JH	Date	20200501
Check		Date	

 光鉛企業股份有限公司 KEEN CHIEF CO., LTD.	Title	S08-SMD-33B
	No.	MT-SYN-380-10