

TABLE OF CONTENT

| No. | Title |
|------------------|---------------------------------|
| MT-SYN-380-01 | Power |
| MT-SYN-380-02 | 3Ø380VAC |
| MT-SYN-380-02-1 | S08-SMD-33B |
| MT-SYN-380-03 | 1Ø220VAC |
| MT-SYN-380-04 | 1Ø110VAC-1 |
| MT-SYN-380-04-01 | 1Ø110VAC-2 |
| MT-SYN-380-05 | 24VDC (24/0) |
| MT-SYN-380-05-01 | 24VDC (24V1/0V1) |
| MT-SYN-380-05-02 | 24VDC (149/151) |
| MT-SYN-380-06 | Controller and Operation pannel |
| MT-SYN-380-07 | 24 PIN - Barloader Interface |
| MT-SYN-380-08 | Input Interface |
| MT-SYN-380-09 | Output Interface |
| MT-SYN-380-AP-1 | REMEF22111601TF-5M-V2 |
| MT-SYN-380-AP-2 | SYNTEC TB-16-OUT |
| MT-SYN-380-AP-3 | SYNTEC TB-16-IN |
| MT-SYN-380-AP-4 | IR-20 OR MOH-20 |

NOTE

| | | | |
|--------|--------|------|----------|
| Model | MT | | |
| Spec. | SYNTEC | | |
| Design | | Date | |
| Draw | JH | Date | 20191110 |
| Check | | Date | |



光鉛企業股份有限公司
KEEN CHIEF CO., LTD.

| | |
|-------|------------------|
| Title | Table of Content |
| No. | MT-SYN-380-Index |

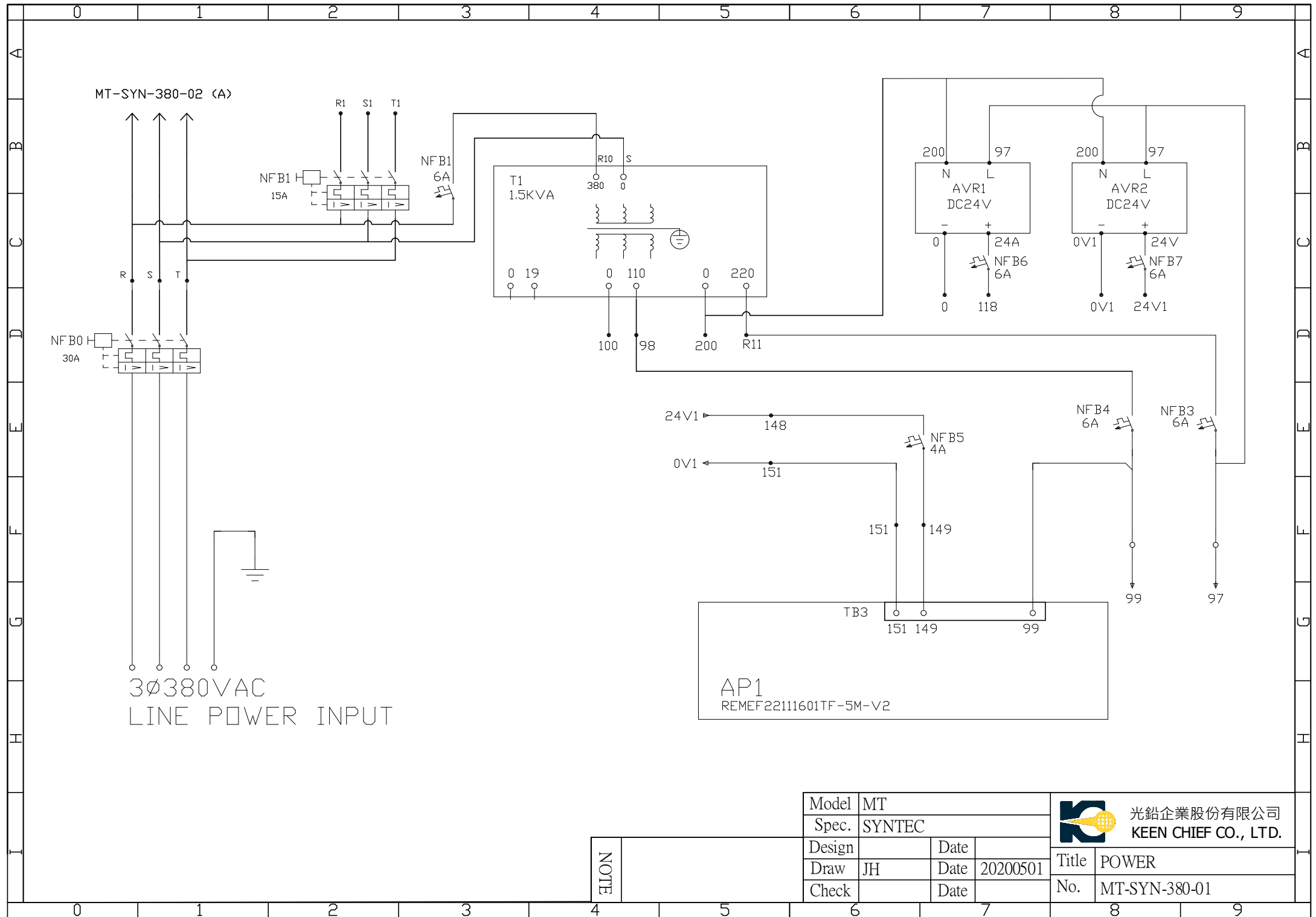

MT-SYN-380-02 (A)

3Ø380VAC
LINE POWER INPUT

AP1
REMEF22111601TF-5M-V2

| | | | |
|--------|--------|------|----------|
| Model | MT | | |
| Spec. | SYNTEC | | |
| Design | | Date | |
| Draw | JH | Date | 20200501 |
| Check | | Date | |

| | | |
|--|-------|---------------|
|  光鉛企業股份有限公司 KEEN CHIEF CO., LTD. | Title | POWER |
| | No. | MT-SYN-380-01 |

NOTE

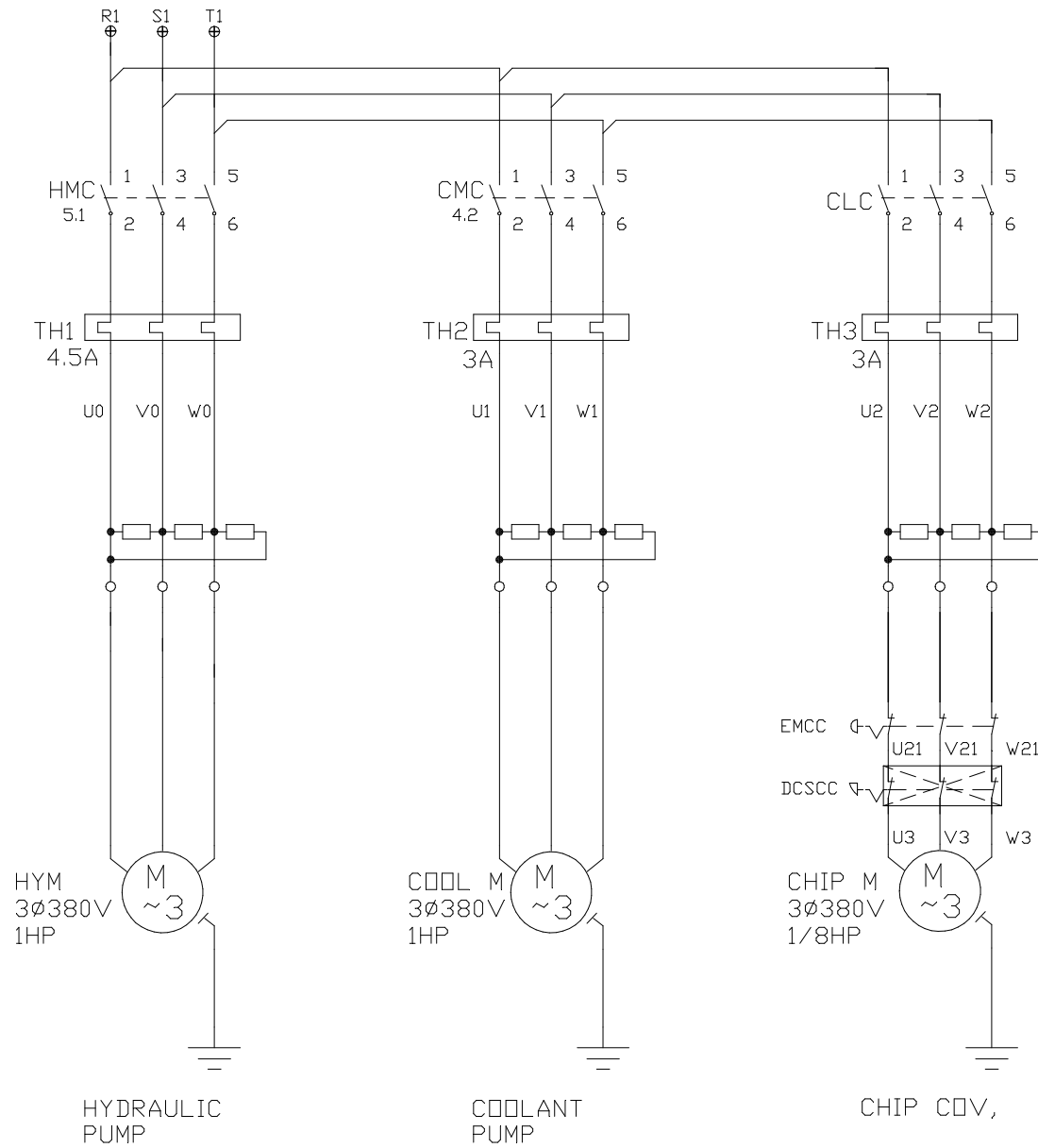

NOTE

| | | | |
|--------|--------|------|----------|
| Model | MT | | |
| Spec. | SYNTEC | | |
| Design | | Date | |
| Draw | JH | Date | 20200501 |
| Check | | Date | |

| | | |
|--|-------|---------------|
|  光鉛企業股份有限公司 KEEN CHIEF CO., LTD. | Title | 3Ø380V |
| | No. | MT-SYN-380-02 |

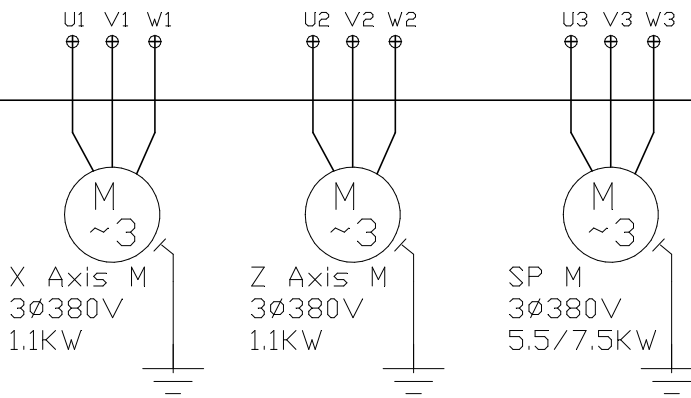
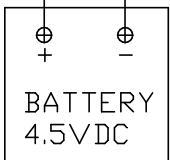
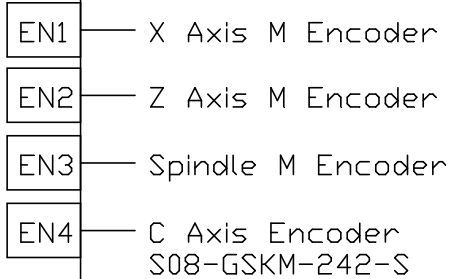
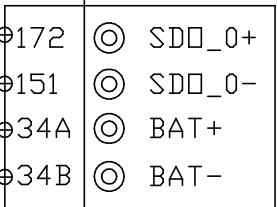
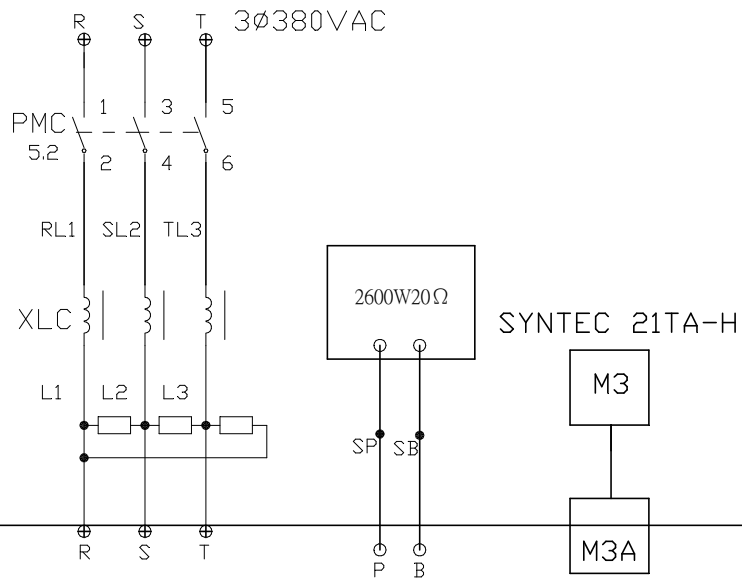
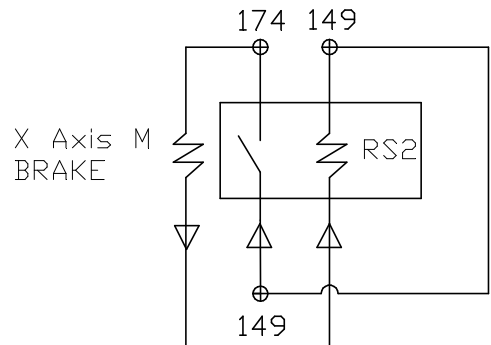

NOTE

| | | | |
|--------|--------|------|----------|
| Model | MT | | |
| Spec. | SYNTEC | | |
| Design | | Date | |
| Draw | JH | Date | 20200501 |
| Check | | Date | |

光鉛企業股份有限公司
KEEN CHIEF CO., LTD.

| | |
|-------|-----------------|
| Title | S08-SMD-33B |
| No. | MT-SYN-380-02-1 |

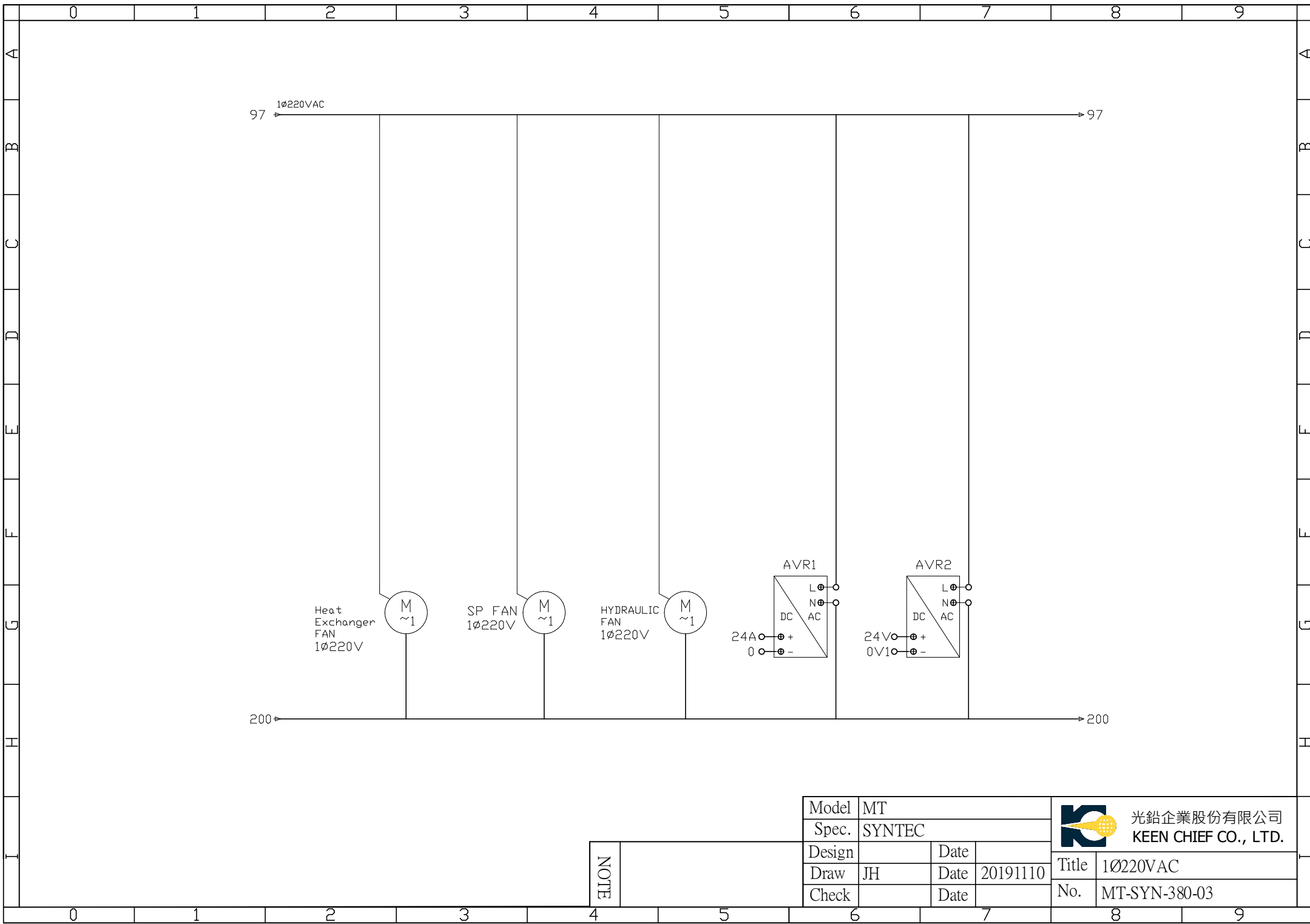

NOTE

| | | | |
|--------|--------|------|----------|
| Model | MT | | |
| Spec. | SYNTEC | | |
| Design | | Date | |
| Draw | JH | Date | 20191110 |
| Check | | Date | |



光鉛企業股份有限公司
KEEN CHIEF CO., LTD.

| | | | |
|-------|---------------|--|--|
| Title | 1Ø220VAC | | |
| No. | MT-SYN-380-03 | | |

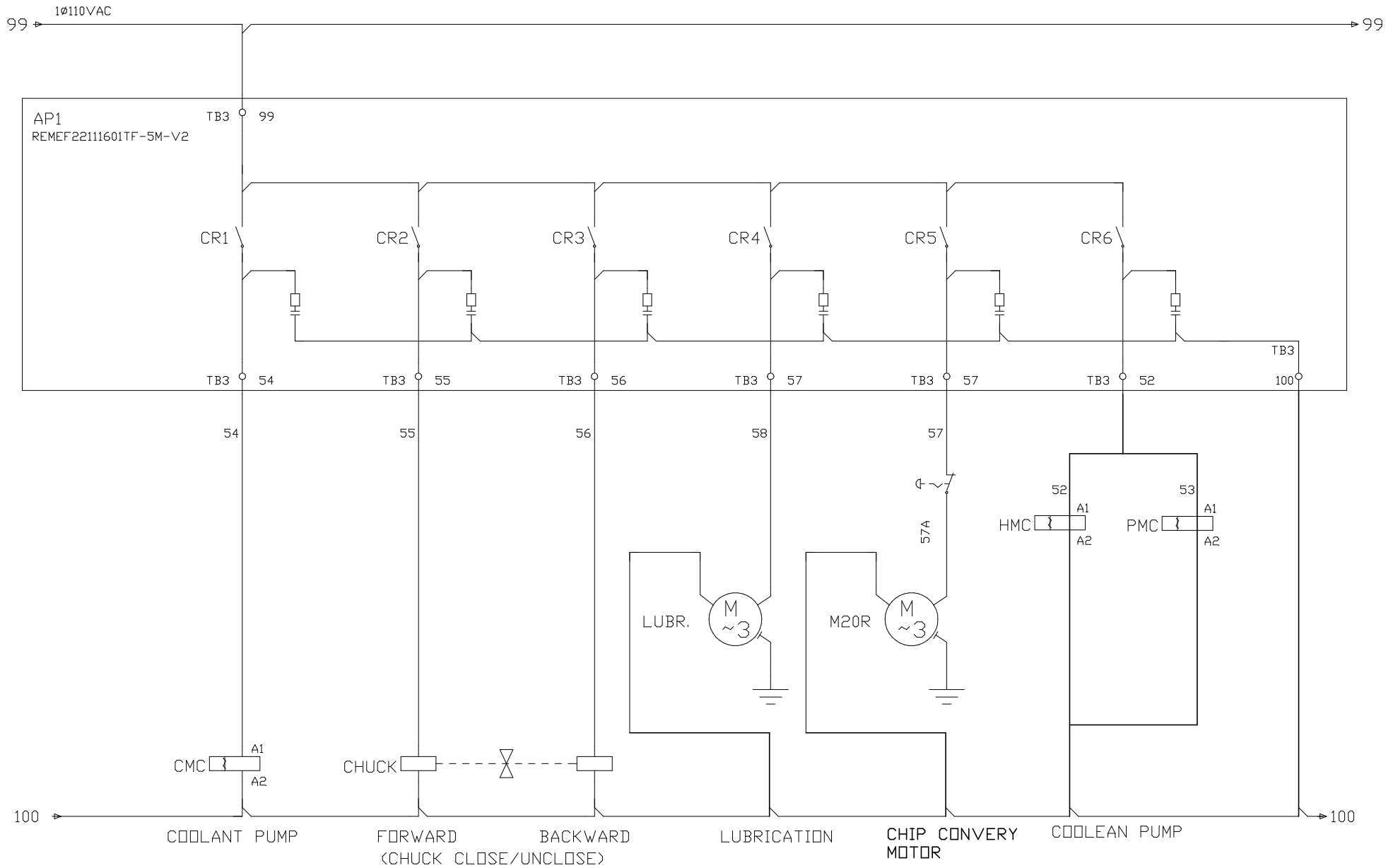

NOTE

| | | |
|--------|--------|---------------|
| Model | MT | |
| Spec. | SYNTEC | |
| Design | | Date |
| Draw | JH | Date 20200501 |
| Check | | Date |

| | | |
|--|-------|---------------|
|  光鉛企業股份有限公司 KEEN CHIEF CO., LTD. | Title | 1Ø110VAC |
| | No. | MT-SYN-380-04 |

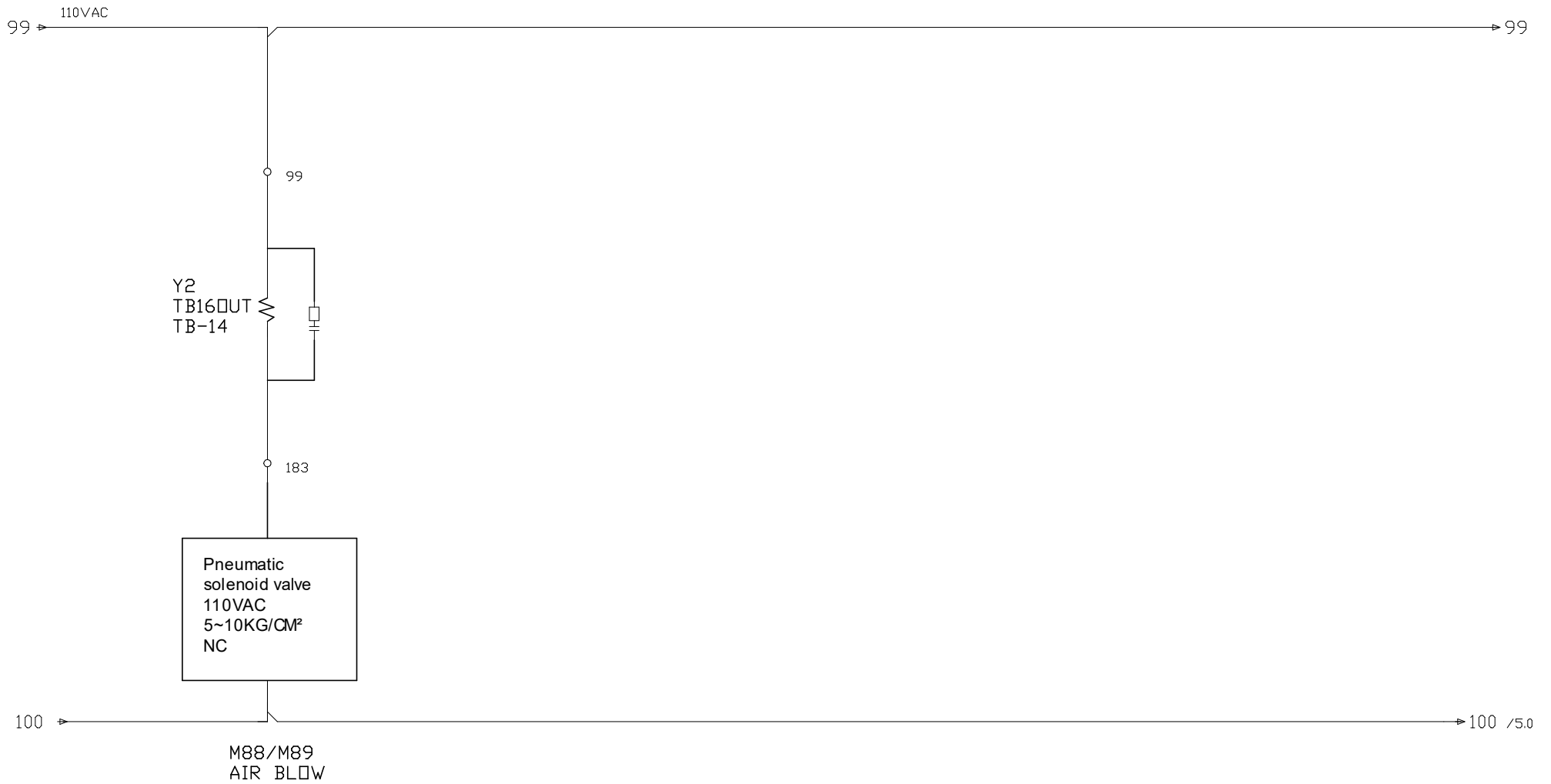

NOTE

| | | | |
|--------|--------|------|----------|
| Model | MT | | |
| Spec. | SYNTEC | | |
| Design | | Date | |
| Draw | JH | Date | 20200501 |
| Check | | Date | |



光鉛企業股份有限公司
KEEN CHIEF CO., LTD.

| | |
|-------|------------------|
| Title | 1Ø110VAC |
| No. | MT-SYN-380-04-01 |

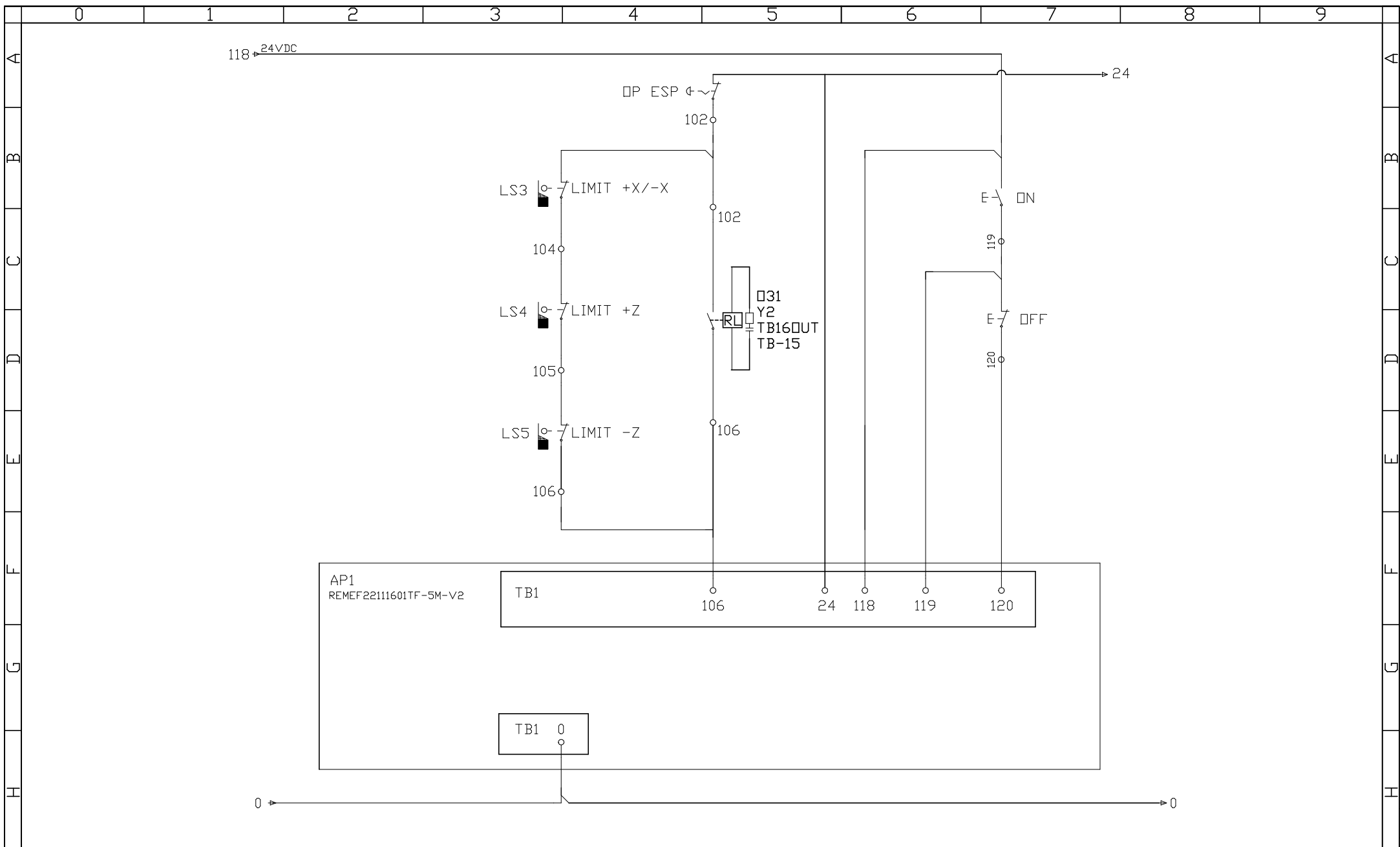

NOTE

| | | | |
|--------|--------|------|----------|
| Model | MT | | |
| Spec. | SYNTEC | | |
| Design | | Date | |
| Draw | JH | Date | 20200501 |
| Check | | Date | |

| | | |
|---|------------------------------------|--------------|
|  | 光鉛企業股份有限公司 KEEN CHIEF CO., LTD. | |
| | Title | 24VDC (24/0) |
| No. | MT-SYN-380-05 | |

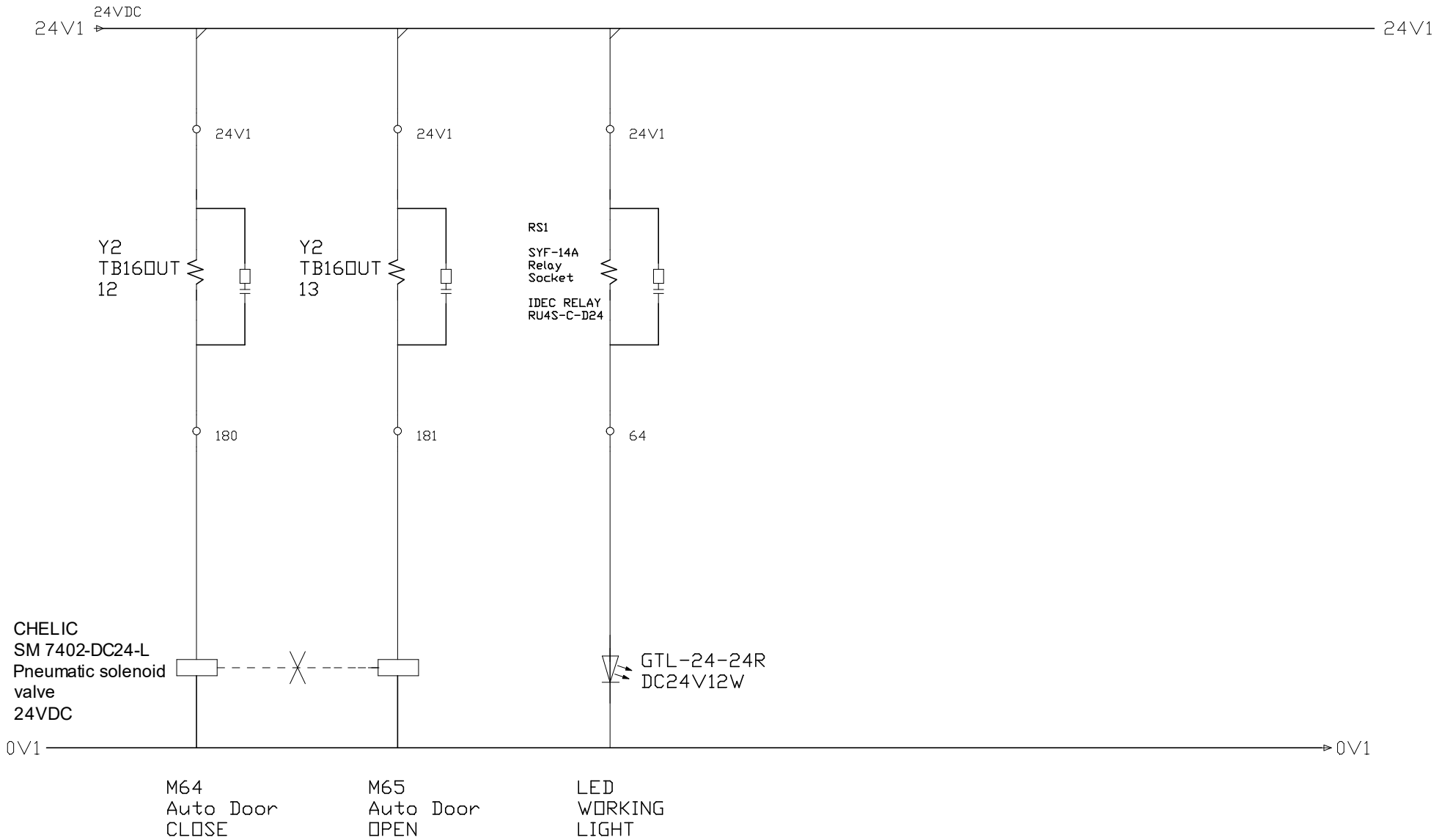

NOTE

| | | | |
|--------|--------|------|----------|
| Model | MT | | |
| Spec. | SYNTEC | | |
| Design | | Date | |
| Draw | JH | Date | 20200501 |
| Check | | Date | |



光鉛企業股份有限公司
KEEN CHIEF CO., LTD.

| | |
|-------|------------------|
| Title | 24VDC (24V1/0V1) |
| No. | MT-SYN-380-05-01 |

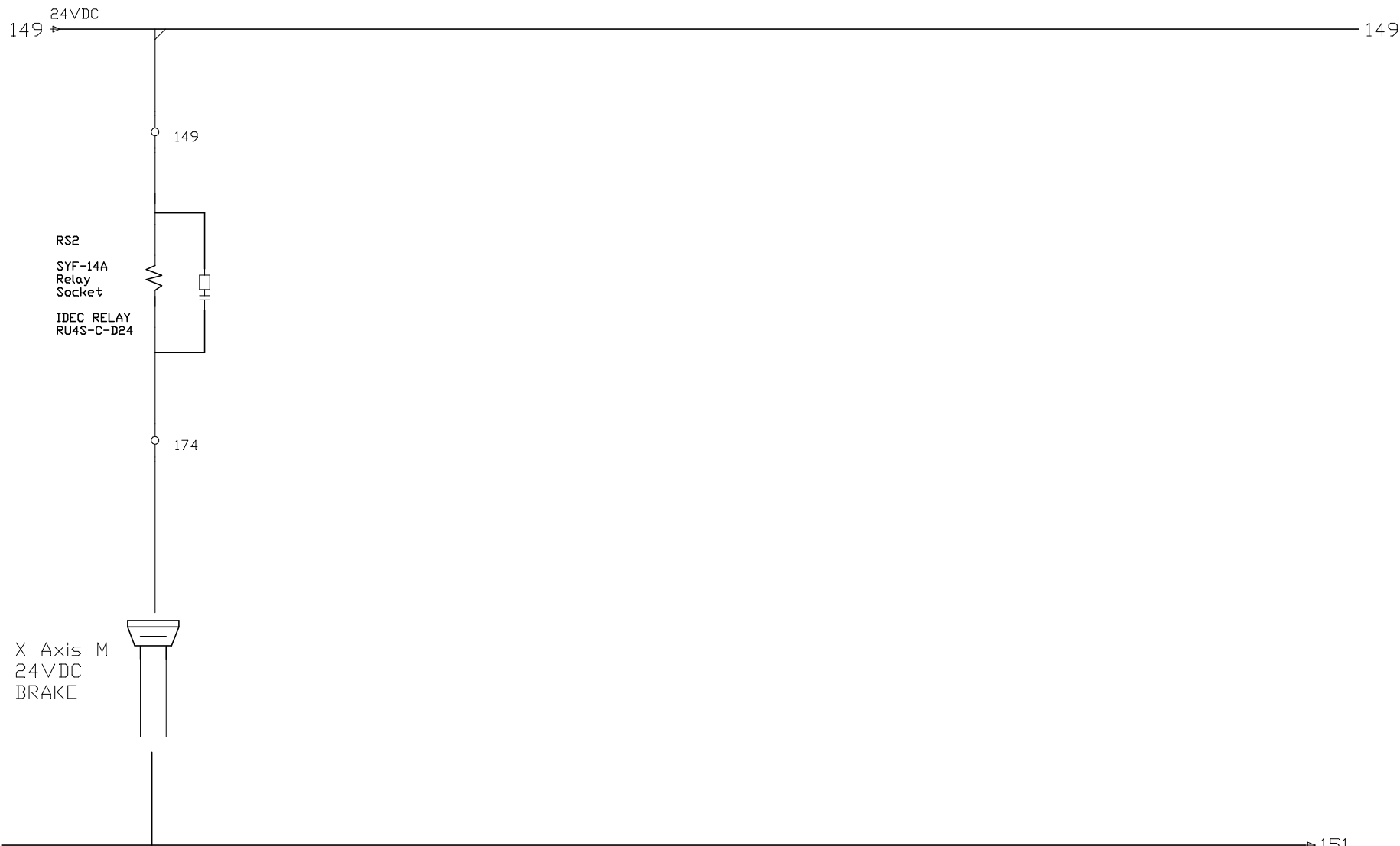

RS2
SYF-14A
Relay
Socket
IDEC RELAY
RU4S-C-D24

X Axis M
24VDC
BRAKE

X AXIS BRAKE
24VDC

NOTE

| | | | |
|--------|--------|------|----------|
| Model | MT | | |
| Spec. | SYNTEC | | |
| Design | | Date | |
| Draw | | Date | 20200501 |
| Check | | Date | |



光鉛企業股份有限公司
KEEN CHIEF CO., LTD.

| | |
|-------|------------------|
| Title | 24VDC (149/151) |
| No. | MT-SYN-380-05-02 |

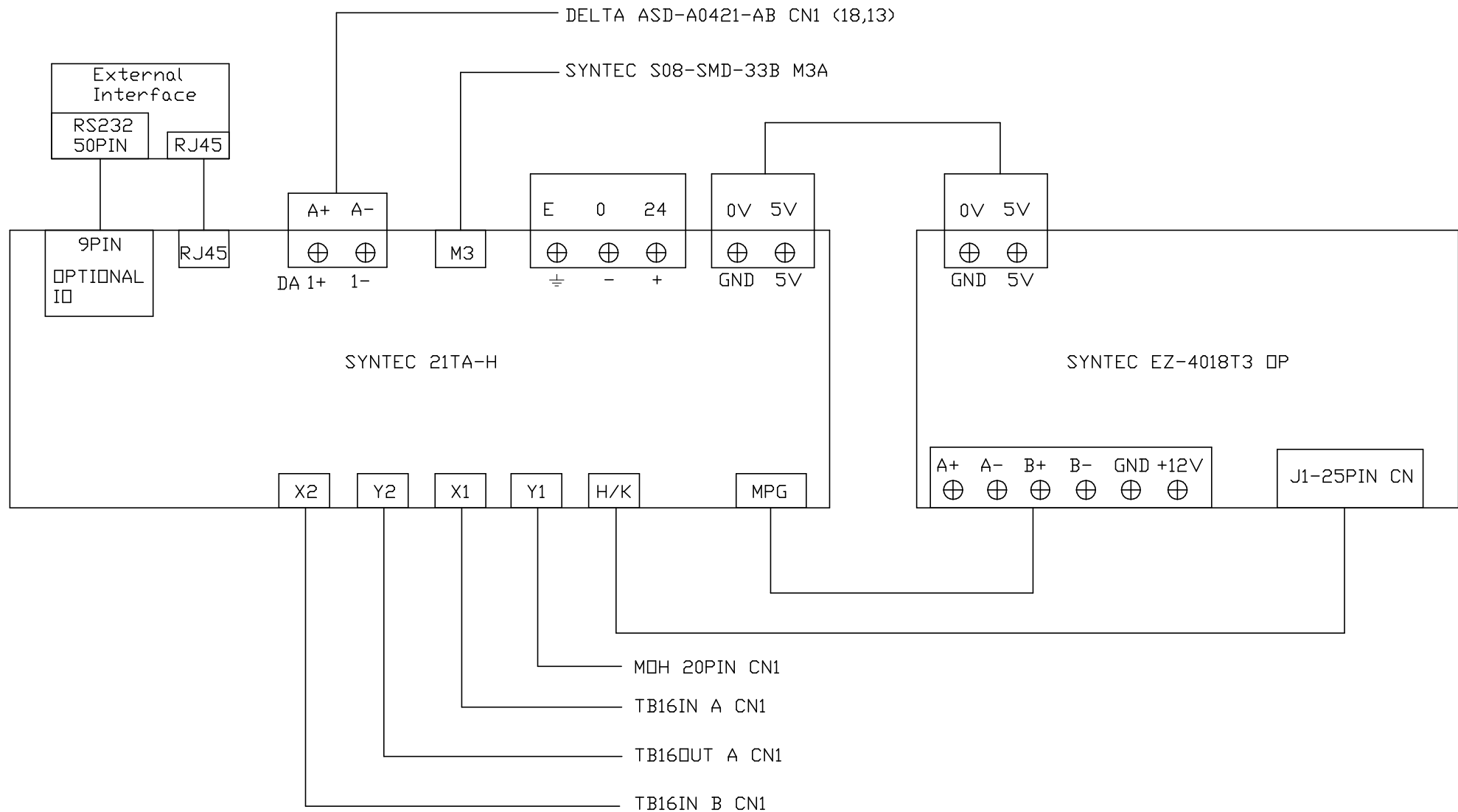

NOTE

| | | | |
|--------|--------|------|----------|
| Model | MT | | |
| Spec. | SYNTEC | | |
| Design | | Date | |
| Draw | JH | Date | 20191124 |
| Check | | Date | |



光鉛企業股份有限公司
KEEN CHIEF CO., LTD.

| | | | |
|-------|-----------------|--|--|
| Title | Controller & OP | | |
| No. | MT-SYN-380-06 | | |

24 PIN INTERFACE

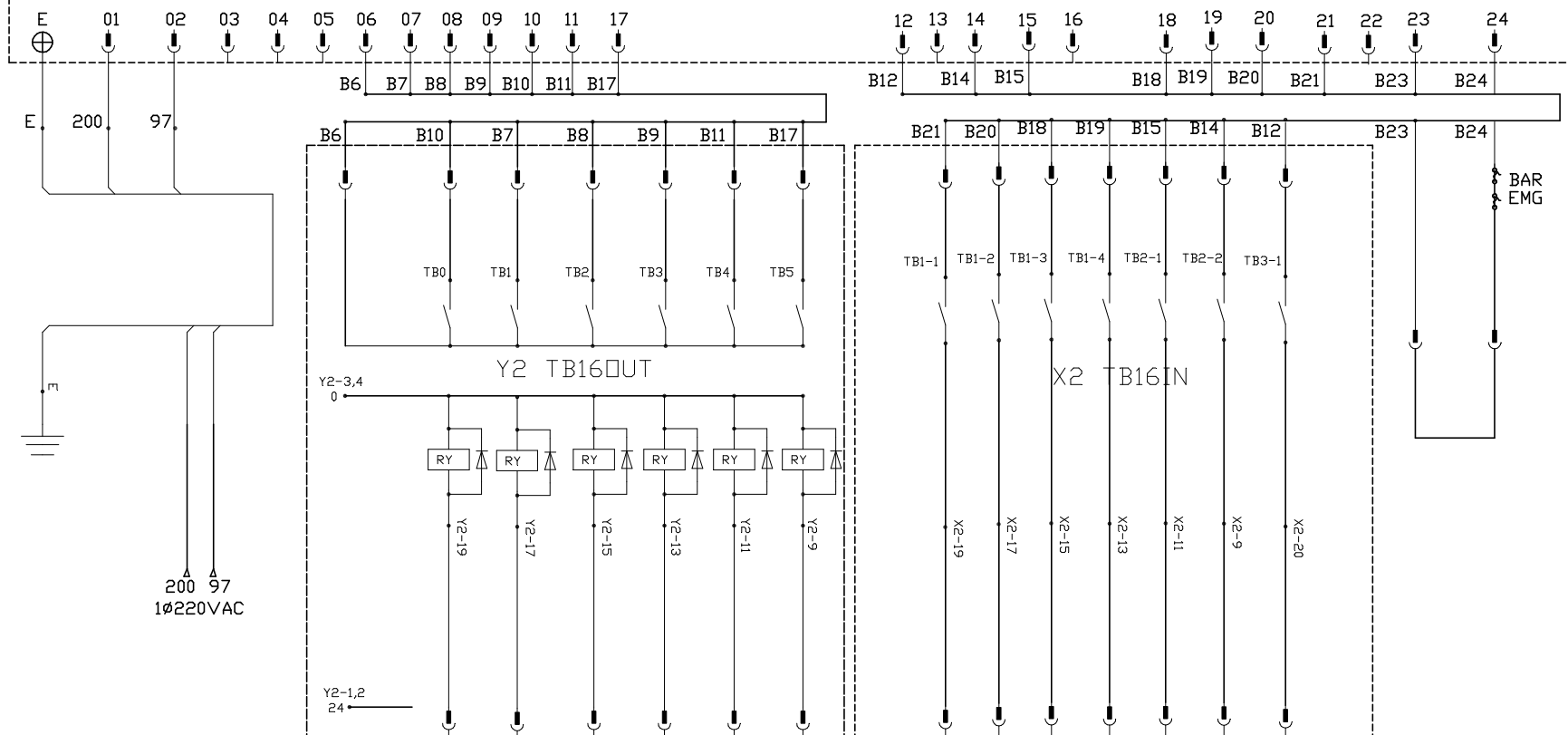

- 21 Barloader: Not Used
- 20 Barloader: CNC Auto Mode
- 19 Barloader: CNC Alarm
- 18 Barloader: M31 Barfeeder Start
- 17 Barloader: SP. CHUCK UNCLAMP READY
- 16 Barloader: M94 Back start
- 124 Barloader: Hold
- 121 Barloader: In Work
- 120 Barloader: Auto Mode
- 119 Barloader: Inch Mode
- 118 Barloader: Alarm
- 117 Barloader: End
- 116 Barloader: Start

NOTE

| | | | |
|--------|--------|------|----------|
| Model | MT | | |
| Spec. | SYNTEC | | |
| Design | | Date | |
| Draw | JH | Date | 20191124 |
| Check | | Date | |

| | | |
|--|-------|----------------------------|
|  光鉛企業股份有限公司 KEEN CHIEF CO., LTD. | Title | 24 PIN-Barloader Interface |
| | No. | MT-SYN-380-07 |

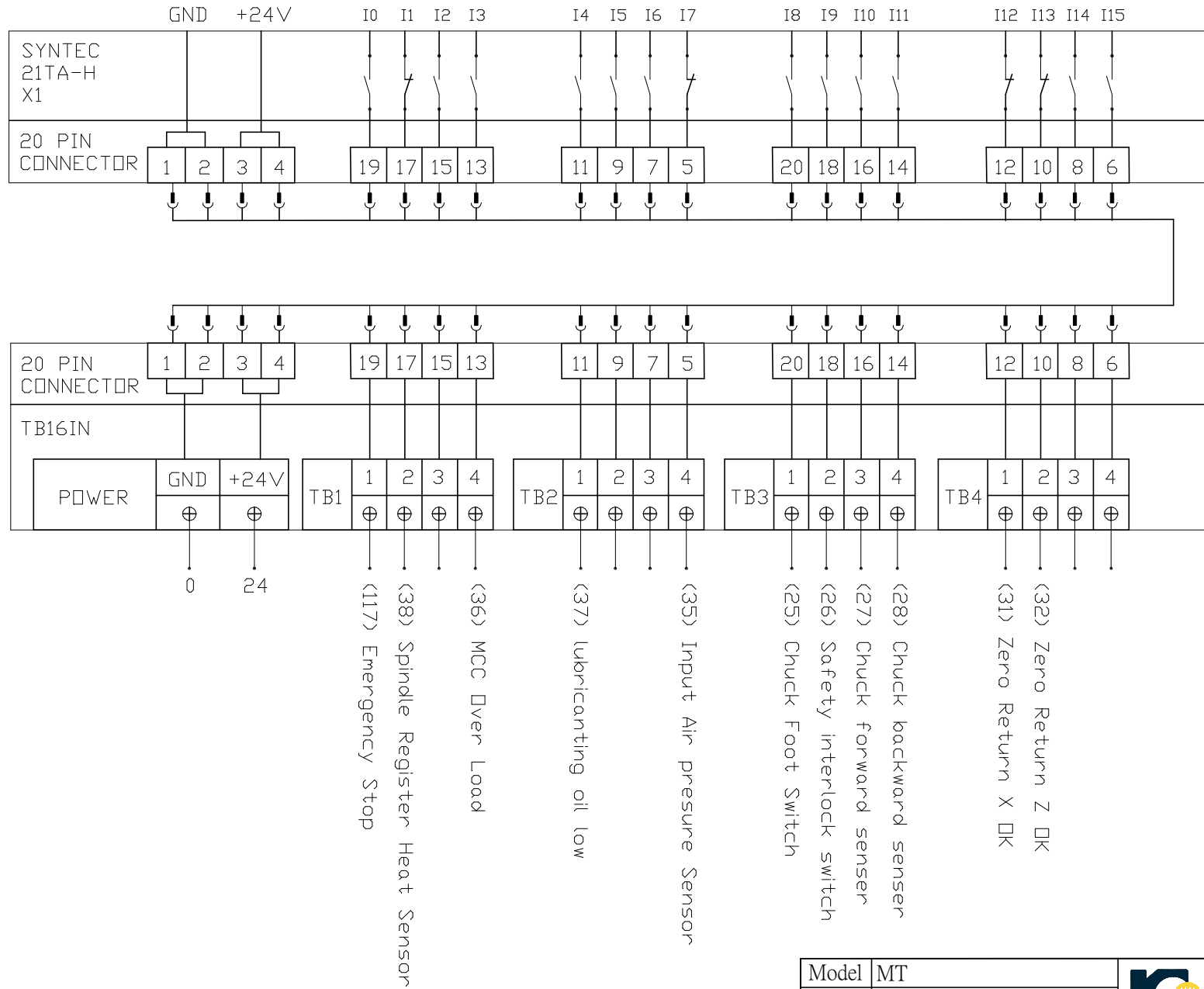

NOTE

| | | | |
|--------|--------|------|----------|
| Model | MT | | |
| Spec. | SYNTEC | | |
| Design | | Date | |
| Draw | JH | Date | 20200501 |
| Check | | Date | |



光鉛企業股份有限公司
KEEN CHIEF CO., LTD.

| | |
|-------|---------------|
| Title | INPUT - X1 |
| No. | MT-SYN-380-08 |

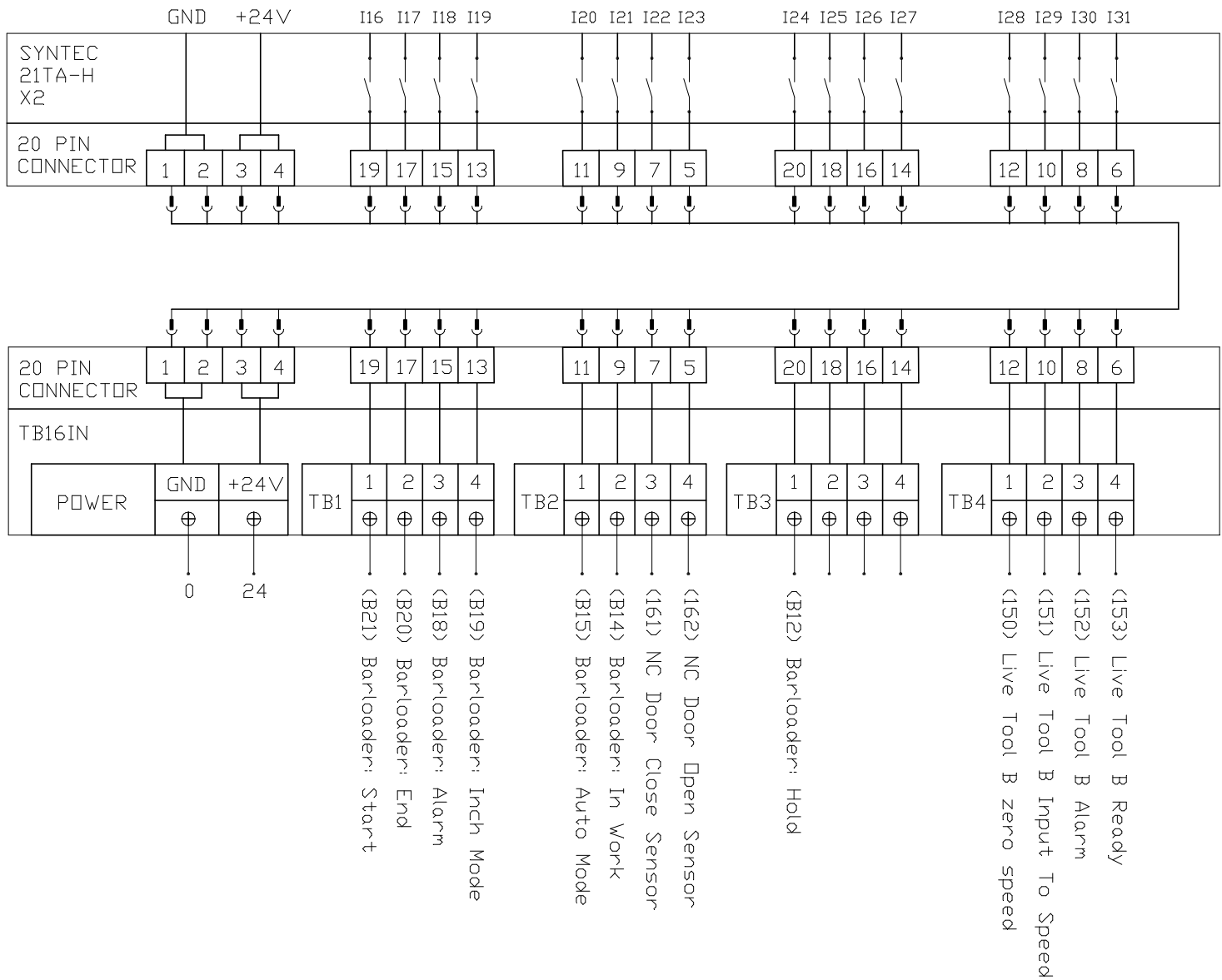

NOTE

| | | | |
|--------|--------|------|----------|
| Model | MT | | |
| Spec. | SYNTEC | | |
| Design | | Date | |
| Draw | JH | Date | 20200501 |
| Check | | Date | |



光鉛企業股份有限公司
KEEN CHIEF CO., LTD.

| | |
|-------|-----------------|
| Title | INPUT - X2 |
| No. | MT-SYN-380-08-1 |

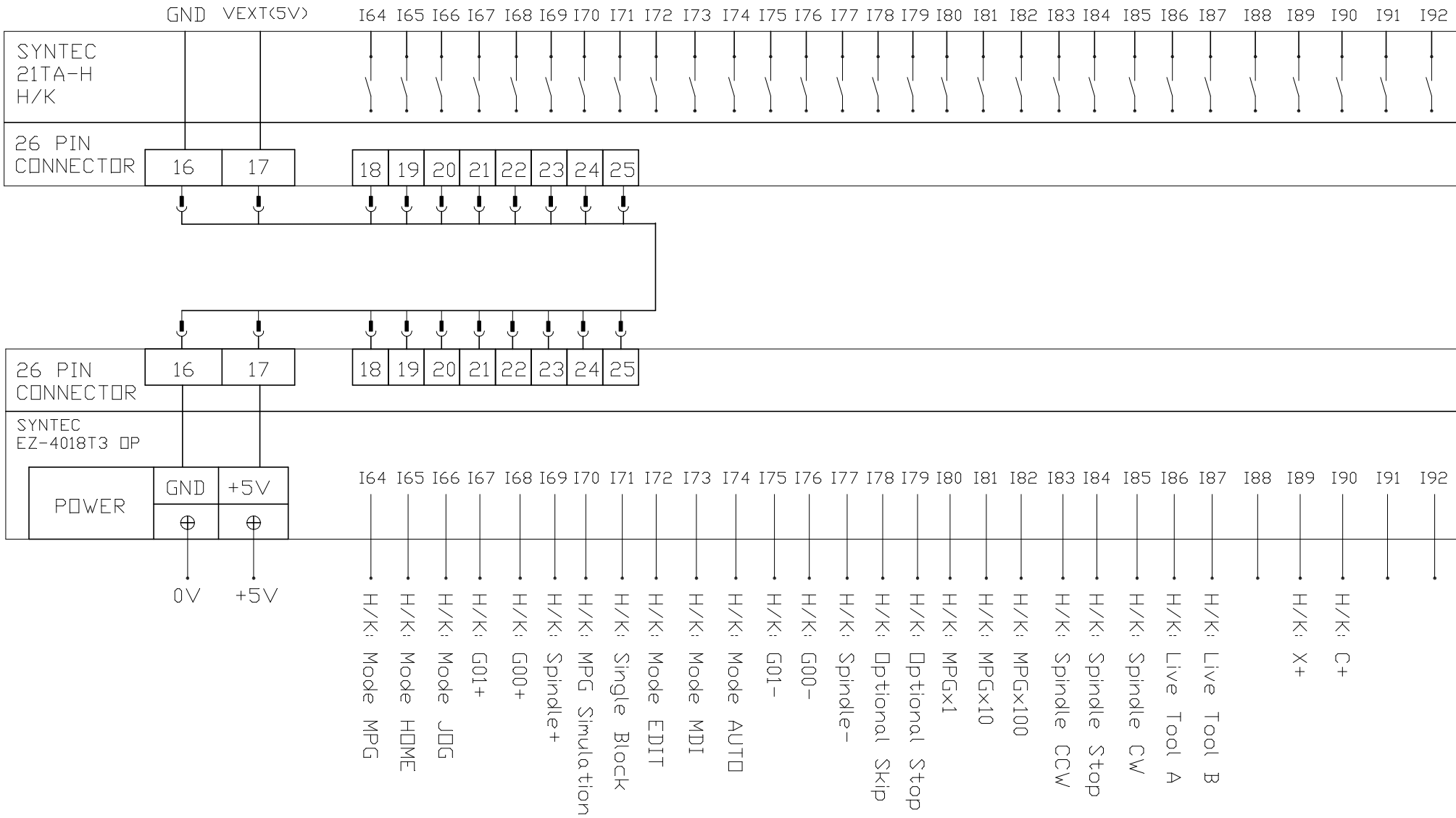

| | | | |
|--------|---------|------|----------|
| Model | MT | | |
| Spec. | SYNTEC | | |
| Design | | Date | |
| Draw | JAY HSU | Date | 20200501 |
| Check | | Date | |



光鉛企業股份有限公司
KEEN CHIEF CO., LTD.

| | | | |
|-------|-----------------|--|--|
| Title | INPUT - OP | | |
| No. | MT-SYN-380-08-2 | | |

NOTE

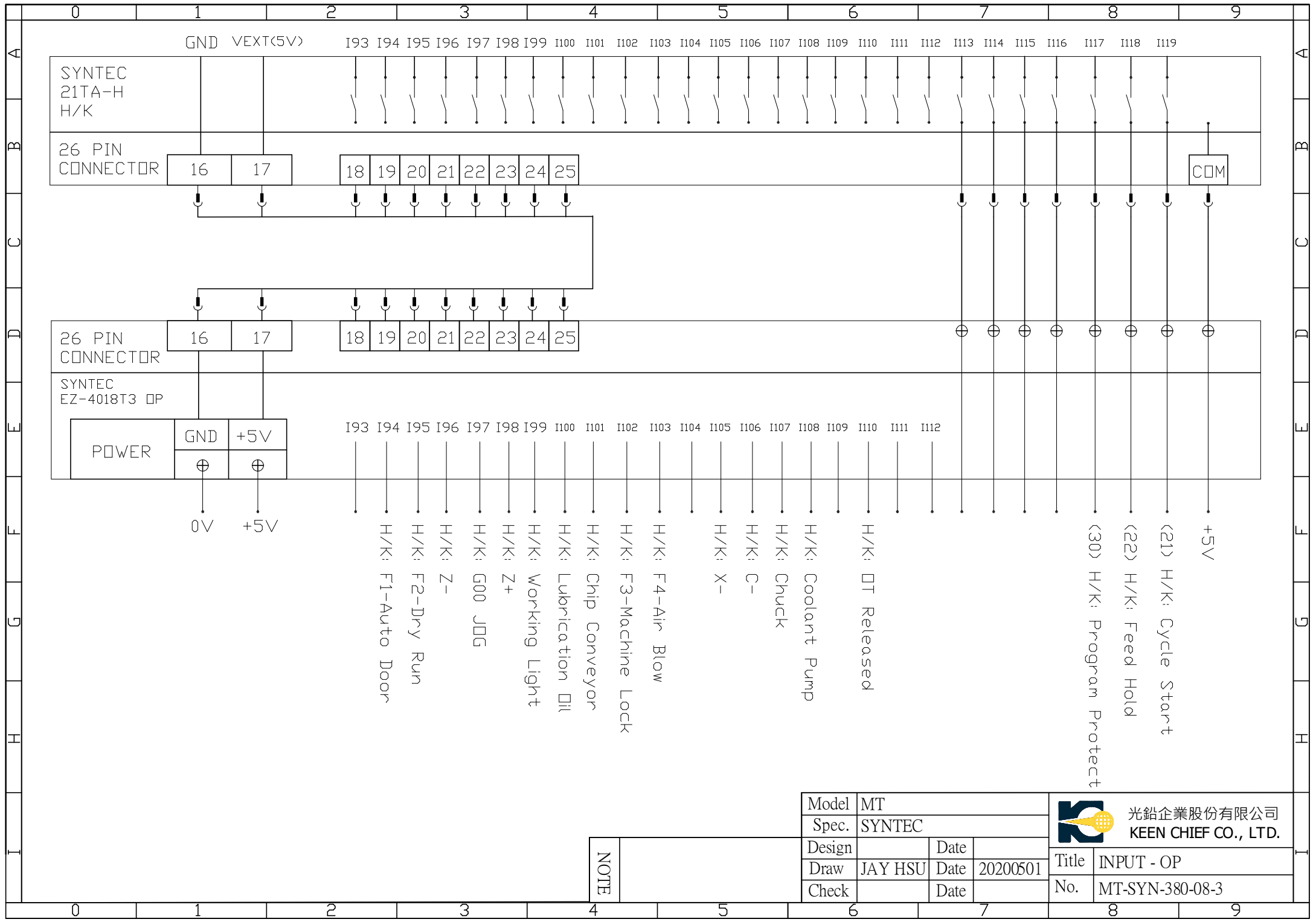

NOTE

| | | | |
|--------|---------|------|----------|
| Model | MT | | |
| Spec. | SYNTEC | | |
| Design | | Date | |
| Draw | JAY HSU | Date | 20200501 |
| Check | | Date | |



光鉛企業股份有限公司
KEEN CHIEF CO., LTD.

| | | | |
|-------|-----------------|--|--|
| Title | INPUT - OP | | |
| No. | MT-SYN-380-08-3 | | |

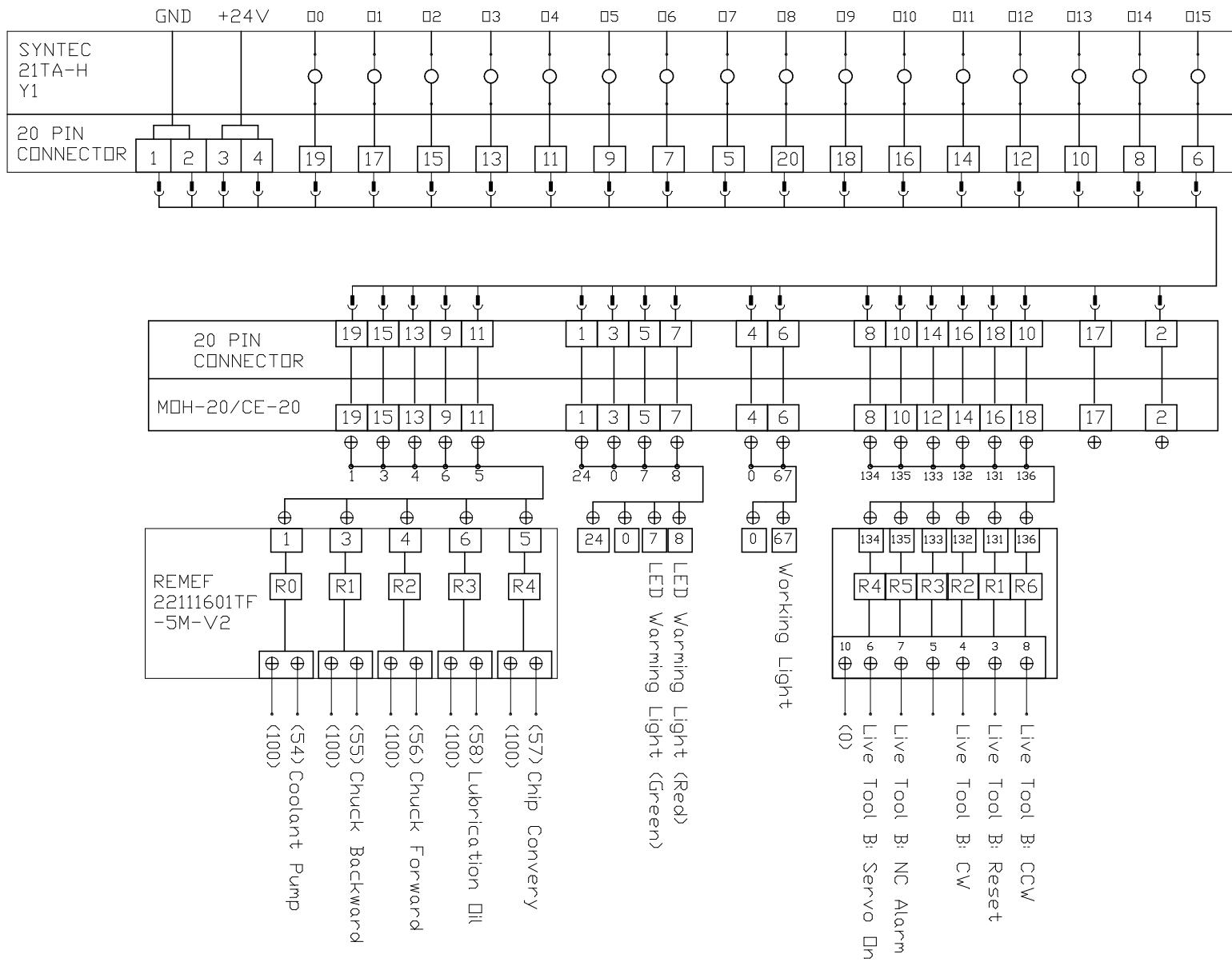

NOTE

| | | | |
|--------|---------|------|----------|
| Model | MT | | |
| Spec. | SYNTEC | | |
| Design | | Date | |
| Draw | JAY HSU | Date | 20200501 |
| Check | | Date | |



光鉛企業股份有限公司
KEEN CHIEF CO., LTD.

| | |
|-------|---------------|
| Title | OUTPUT - Y1 |
| No. | MT-SYN-380-09 |

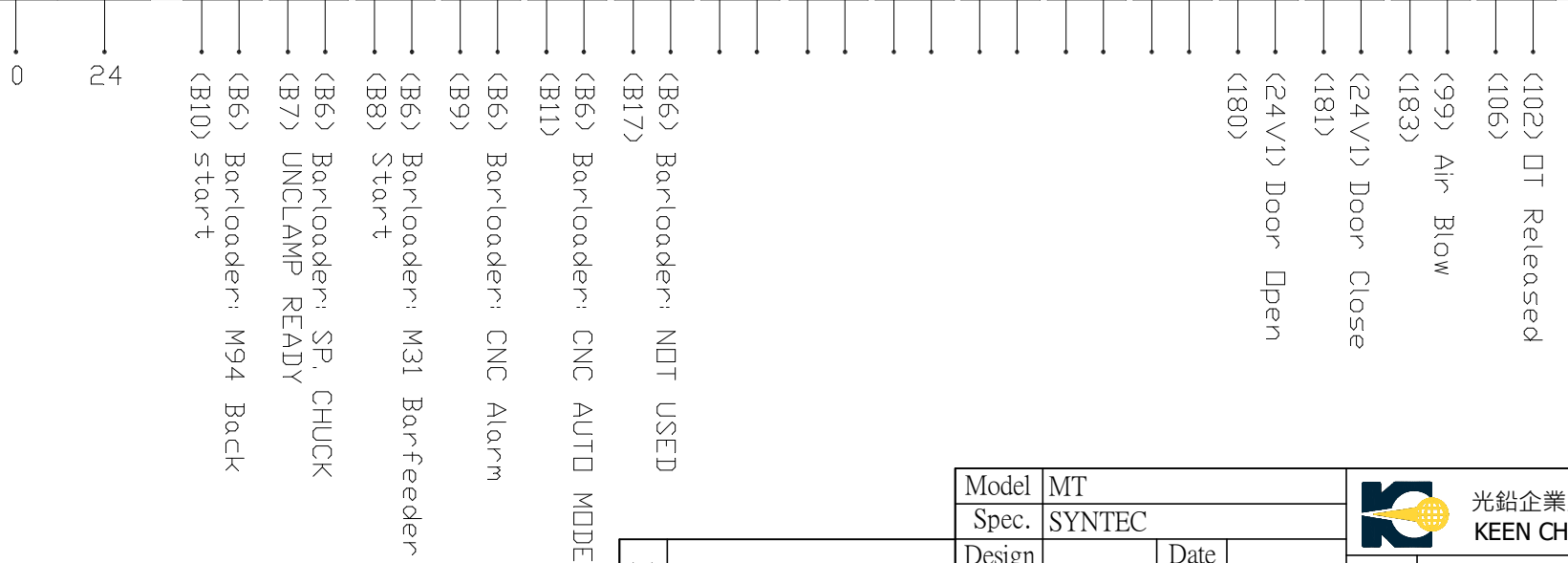
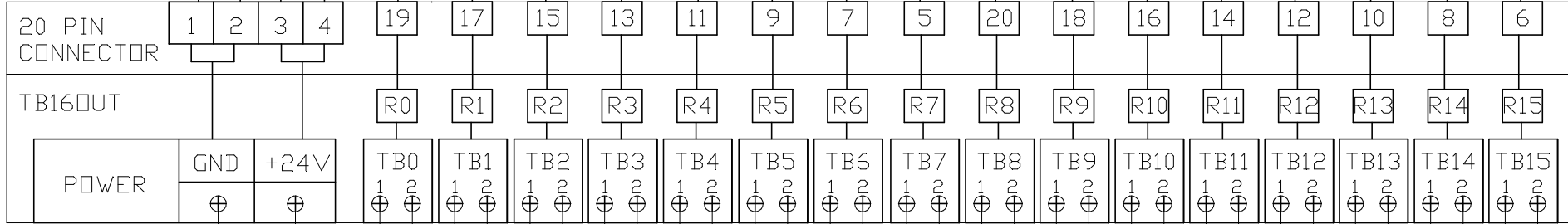
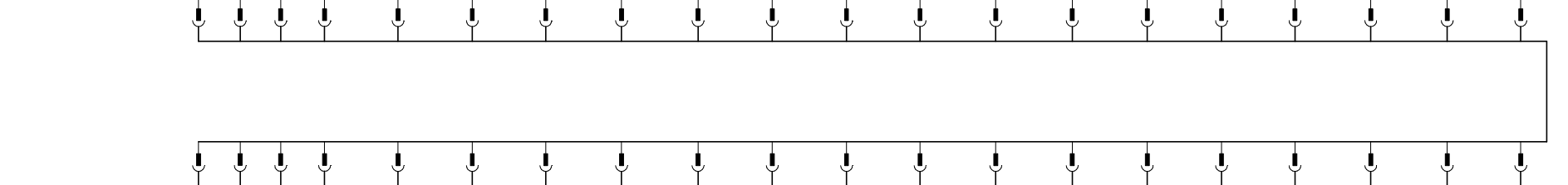
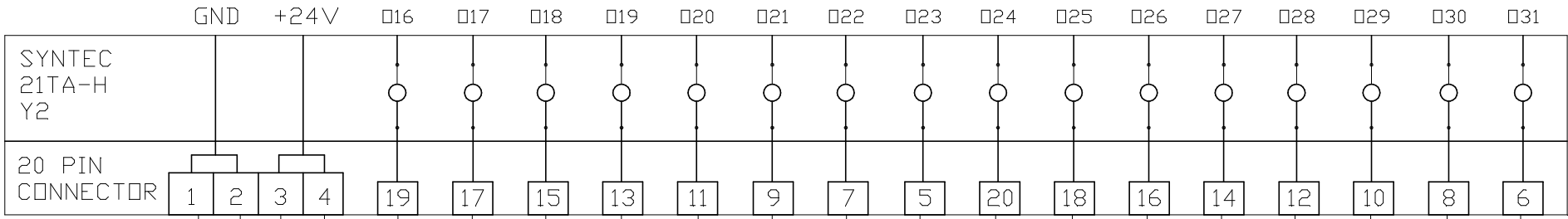

NOTE

| | | | |
|--------|---------|------|----------|
| Model | MT | | |
| Spec. | SYNTEC | | |
| Design | | Date | |
| Draw | JAY HSU | Date | 20200501 |
| Check | | Date | |



| | |
|-------|-----------------|
| Title | OUTPUT-Y2 |
| No. | MT-SYN-380-09-1 |

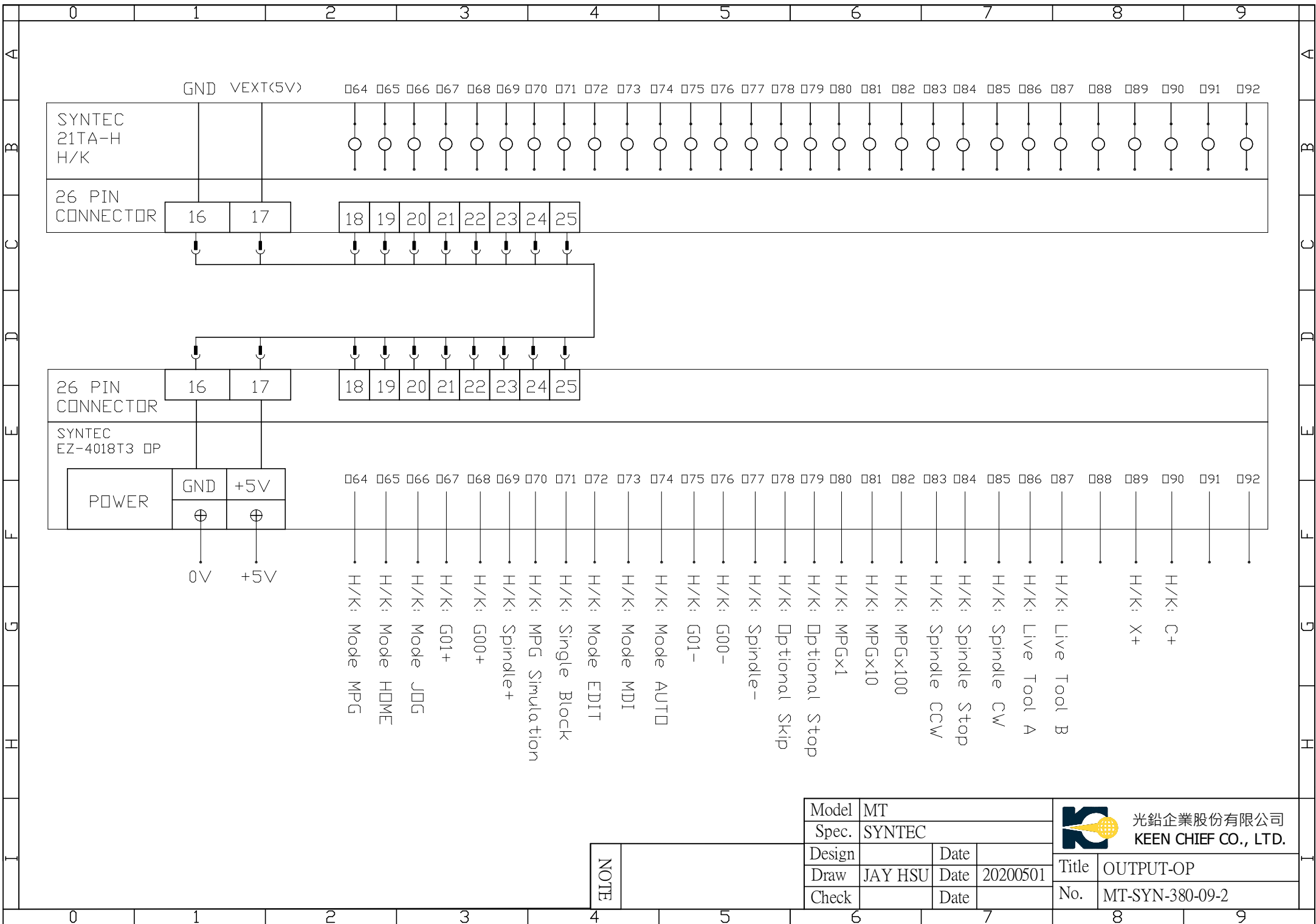

NOTE

| | | | |
|--------|---------|------|----------|
| Model | MT | | |
| Spec. | SYNTEC | | |
| Design | | Date | |
| Draw | JAY HSU | Date | 20200501 |
| Check | | Date | |



光鉛企業股份有限公司
KEEN CHIEF CO., LTD.

| | |
|-------|-----------------|
| Title | OUTPUT-OP |
| No. | MT-SYN-380-09-2 |

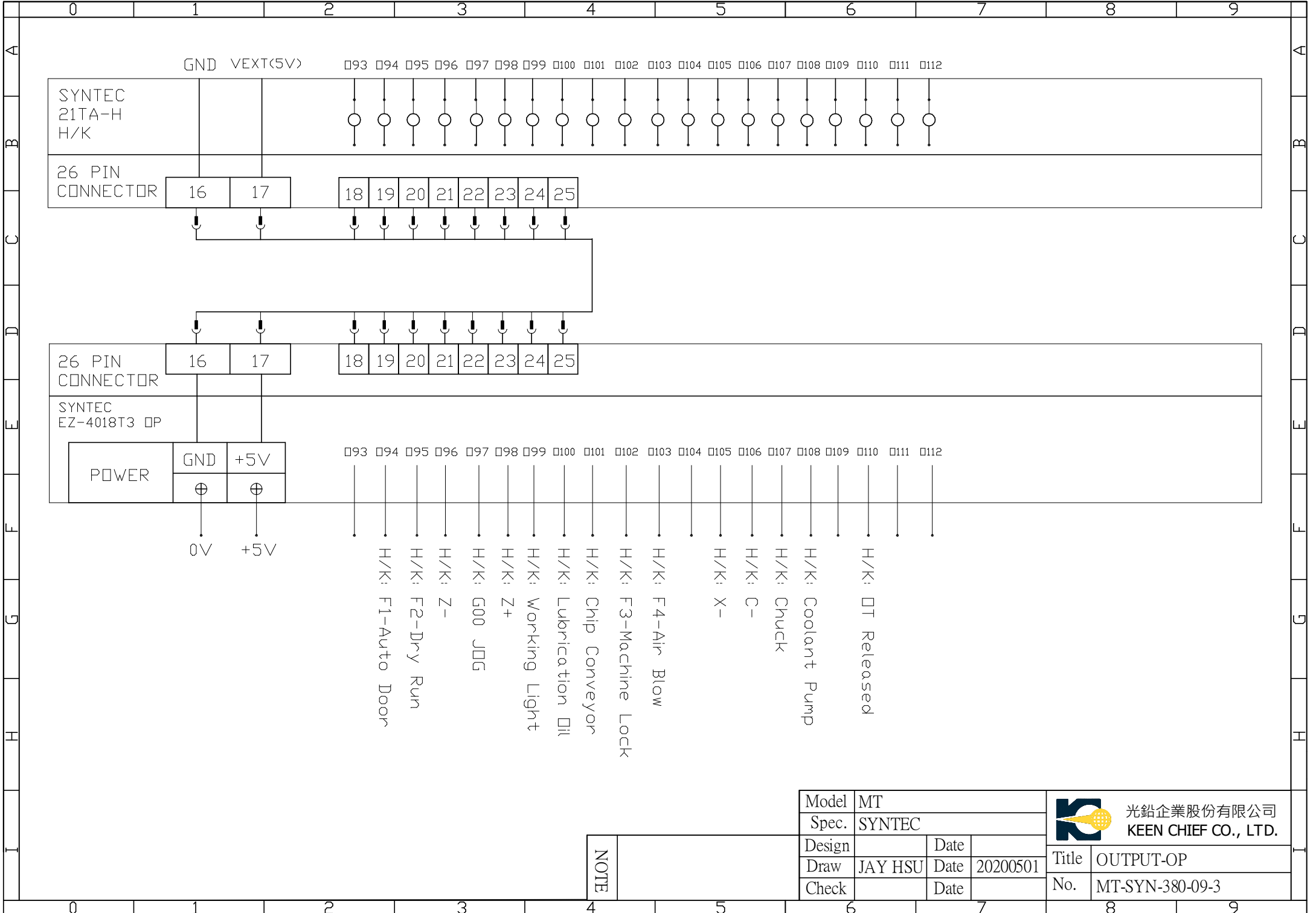

NOTE

| | | | |
|--------|---------|------|----------|
| Model | MT | | |
| Spec. | SYNTEC | | |
| Design | | Date | |
| Draw | JAY HSU | Date | 20200501 |
| Check | | Date | |



光鉛企業股份有限公司
KEEN CHIEF CO., LTD.

| | |
|-------|-----------------|
| Title | OUTPUT-OP |
| No. | MT-SYN-380-09-3 |

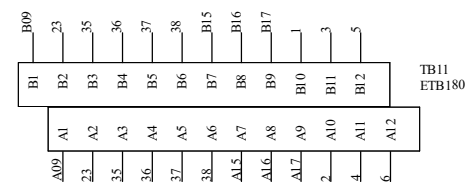
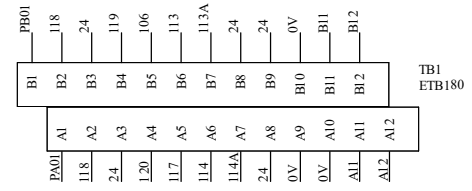
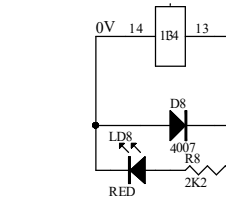
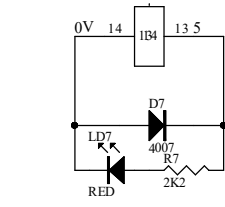
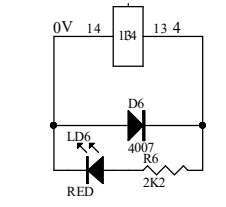
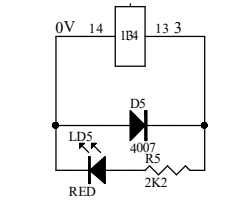
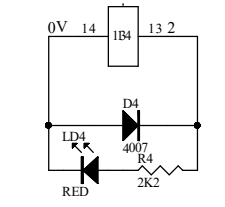
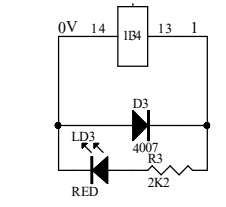
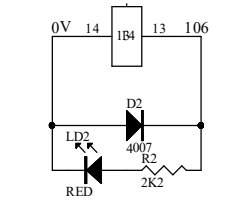
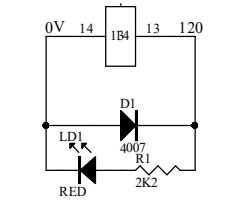
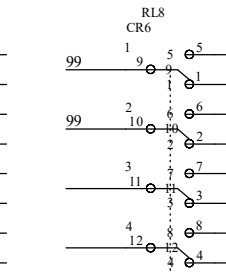
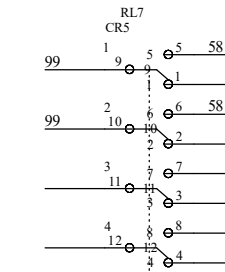
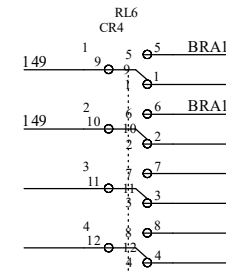
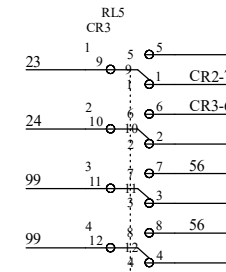
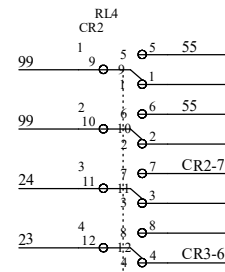
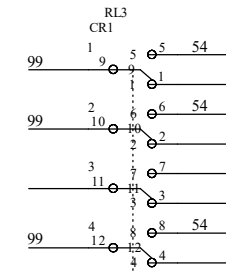
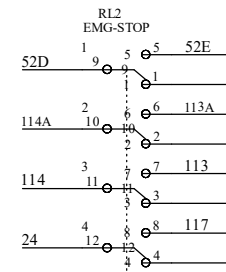
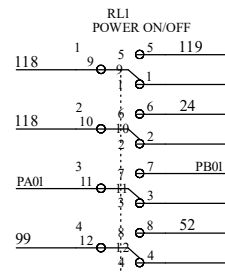
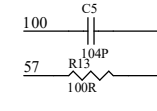
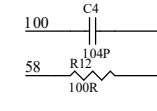
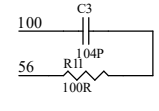
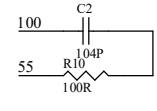
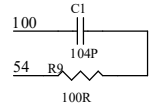
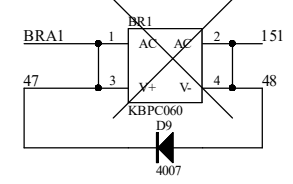
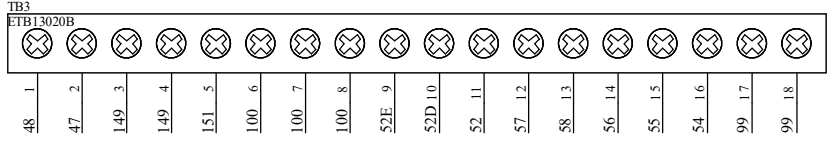

NOTE

| | | |
|--------|--------|----------|
| Model | MT | |
| Spec. | SYNTEC | |
| Design | Date | |
| Draw | Date | 20200501 |
| Check | Date | |

光鉛企業股份有限公司
KEEN CHIEF CO., LTD.

| | |
|-------|-----------------------|
| Title | REMEF22111601TF-5M-V2 |
| No. | MT-SYN-380-AP-1 |

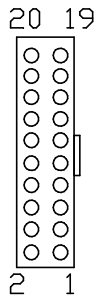

Y1 CONNECTION

| PIN | SIGNAL |
|-----|--------|
| 1 | 24VDC |
| 2 | 24VDC |
| 3 | GND |
| 4 | GND |
| 5 | □7 |
| 6 | □15 |
| 7 | □6 |
| 8 | □14 |
| 9 | □5 |
| 10 | □13 |
| 11 | □4 |
| 12 | □12 |
| 13 | □3 |
| 14 | □11 |
| 15 | □2 |
| 16 | □10 |
| 17 | □1 |
| 18 | □9 |
| 19 | □0 |
| 20 | □8 |

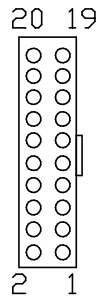

Y2 CONNECTION

| PIN | SIGNAL |
|-----|--------|
| 1 | 24VDC |
| 2 | 24VDC |
| 3 | GND |
| 4 | GND |
| 5 | □23 |
| 6 | □31 |
| 7 | □22 |
| 8 | □30 |
| 9 | □21 |
| 10 | □29 |
| 11 | □20 |
| 12 | □28 |
| 13 | □19 |
| 14 | □27 |
| 15 | □18 |
| 16 | □26 |
| 17 | □17 |
| 18 | □25 |
| 19 | □16 |
| 20 | □24 |

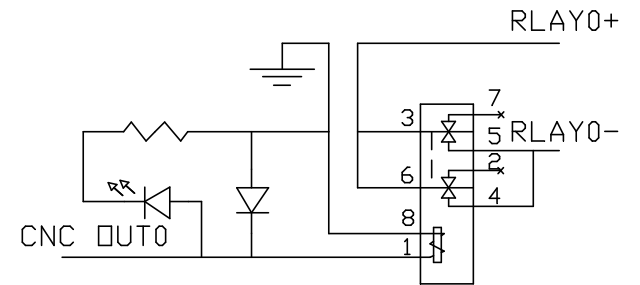

NOTE

| | | | |
|--------|--------|------|----------|
| Model | MT | | |
| Spec. | SYNTEC | | |
| Design | | Date | |
| Draw | JH | Date | 20200501 |
| Check | | Date | |

光鉛企業股份有限公司
KEEN CHIEF CO., LTD.

| | |
|-------|------------------|
| Title | SYNTEC TB-16-OUT |
| No. | MT-SYN-380-AP-2 |

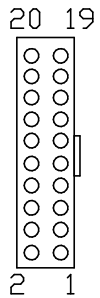

X1 CONNECTION

| PIN | SIGNAL |
|-----|--------|
| 1 | 24VDC |
| 2 | 24VDC |
| 3 | GND |
| 4 | GND |
| 5 | I7 |
| 6 | I15 |
| 7 | I6 |
| 8 | I14 |
| 9 | I5 |
| 10 | I13 |
| 11 | I4 |
| 12 | I12 |
| 13 | I3 |
| 14 | I11 |
| 15 | I2 |
| 16 | I10 |
| 17 | I1 |
| 18 | I9 |
| 19 | I0 |
| 20 | I8 |

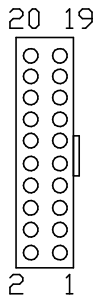

X2 CONNECTION

| PIN | SIGNAL |
|-----|--------|
| 1 | 24VDC |
| 2 | 24VDC |
| 3 | GND |
| 4 | GND |
| 5 | I23 |
| 6 | I31 |
| 7 | I22 |
| 8 | I30 |
| 9 | I21 |
| 10 | I29 |
| 11 | I20 |
| 12 | I28 |
| 13 | I19 |
| 14 | I27 |
| 15 | I18 |
| 16 | I26 |
| 17 | I17 |
| 18 | I25 |
| 19 | I16 |
| 20 | I24 |

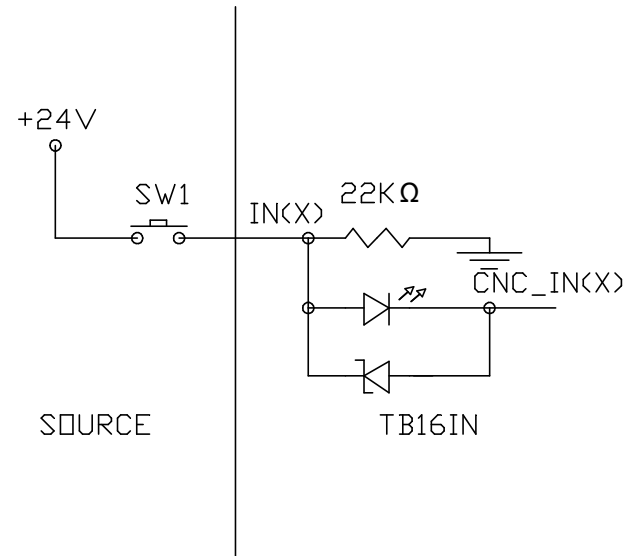

NOTE

| | | | |
|--------|--------|------|----------|
| Model | MT | | |
| Spec. | SYNTEC | | |
| Design | | Date | |
| Draw | JH | Date | 20200501 |
| Check | | Date | |



光鉛企業股份有限公司
KEEN CHIEF CO., LTD.

| | |
|-------|-----------------|
| Title | SYNTEC TB-16-IN |
| No. | MT-SYN-380-AP-3 |

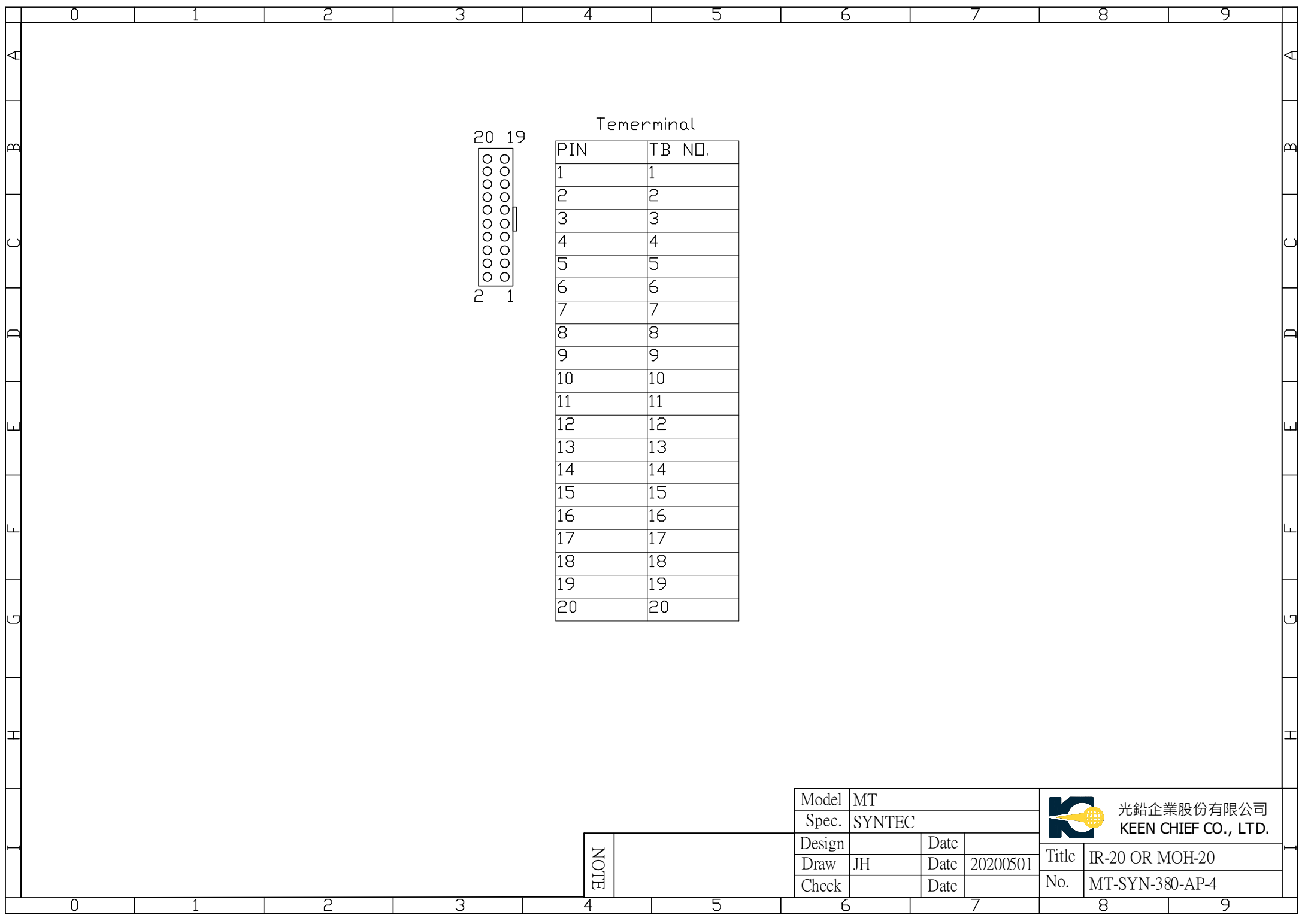

Terminal

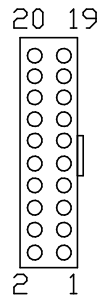

| PIN | TB NO. |
|-----|--------|
| 1 | 1 |
| 2 | 2 |
| 3 | 3 |
| 4 | 4 |
| 5 | 5 |
| 6 | 6 |
| 7 | 7 |
| 8 | 8 |
| 9 | 9 |
| 10 | 10 |
| 11 | 11 |
| 12 | 12 |
| 13 | 13 |
| 14 | 14 |
| 15 | 15 |
| 16 | 16 |
| 17 | 17 |
| 18 | 18 |
| 19 | 19 |
| 20 | 20 |

NOTE

| | | | |
|--------|--------|------|----------|
| Model | MT | | |
| Spec. | SYNTEC | | |
| Design | | Date | |
| Draw | JH | Date | 20200501 |
| Check | | Date | |



光鉛企業股份有限公司
KEEN CHIEF CO., LTD.

| | | | |
|-------|-----------------|--|--|
| Title | IR-20 OR MOH-20 | | |
| No. | MT-SYN-380-AP-4 | | |