

TABLE OF CONTENT

No.	Title
MT-SYN-380-01	Power
MT-SYN-380-02	3Ø380VAC
MT-SYN-380-02-1	S08-SMD-33B
MT-SYN-380-03	1Ø220VAC
MT-SYN-380-04	1Ø110VAC-1
MT-SYN-380-04-01	1Ø110VAC-2
MT-SYN-380-05	24VDC (24/0)
MT-SYN-380-05-01	24VDC (24V1/0V1)
MT-SYN-380-05-02	24VDC (149/151)
MT-SYN-380-06	Controller and Operation pannel
MT-SYN-380-07	24 PIN - Barloader Interface
MT-SYN-380-08	Input Interface
MT-SYN-380-09	Output Interface
MT-SYN-380-AP-1	REMEF22111601TF-5M-V2
MT-SYN-380-AP-2	SYNTEC TB-16-OUT
MT-SYN-380-AP-3	SYNTEC TB-16-IN
MT-SYN-380-AP-4	IR-20 OR MOH-20

NOTE

Model	MT		
Spec.	SYNTEC		
Design		Date	
Draw	JH	Date	20191110
Check		Date	



光鉛企業股份有限公司
KEEN CHIEF CO., LTD.

Title	Table of Content
No.	MT-SYN-380-Index

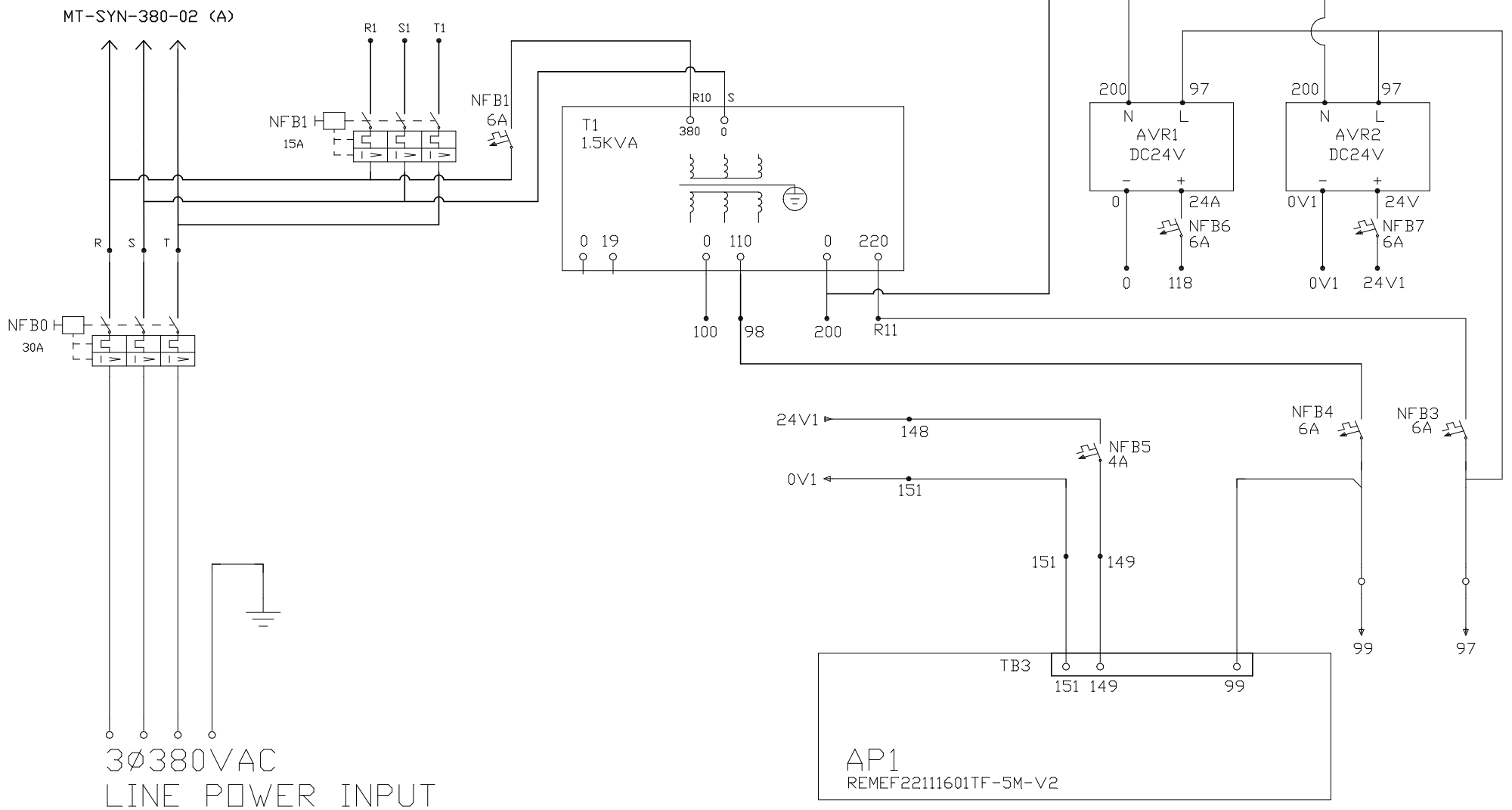

3Ø380VAC
LINE POWER INPUT

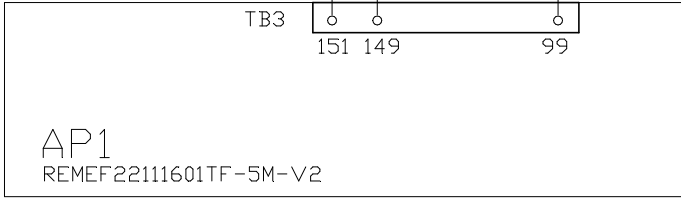

Model	MT		
Spec.	SYNTEC		
Design		Date	
Draw	JH	Date	20200501
Check		Date	

 光鉛企業股份有限公司 KEEN CHIEF CO., LTD.	Title	POWER
	No.	MT-SYN-380-01

NOTE

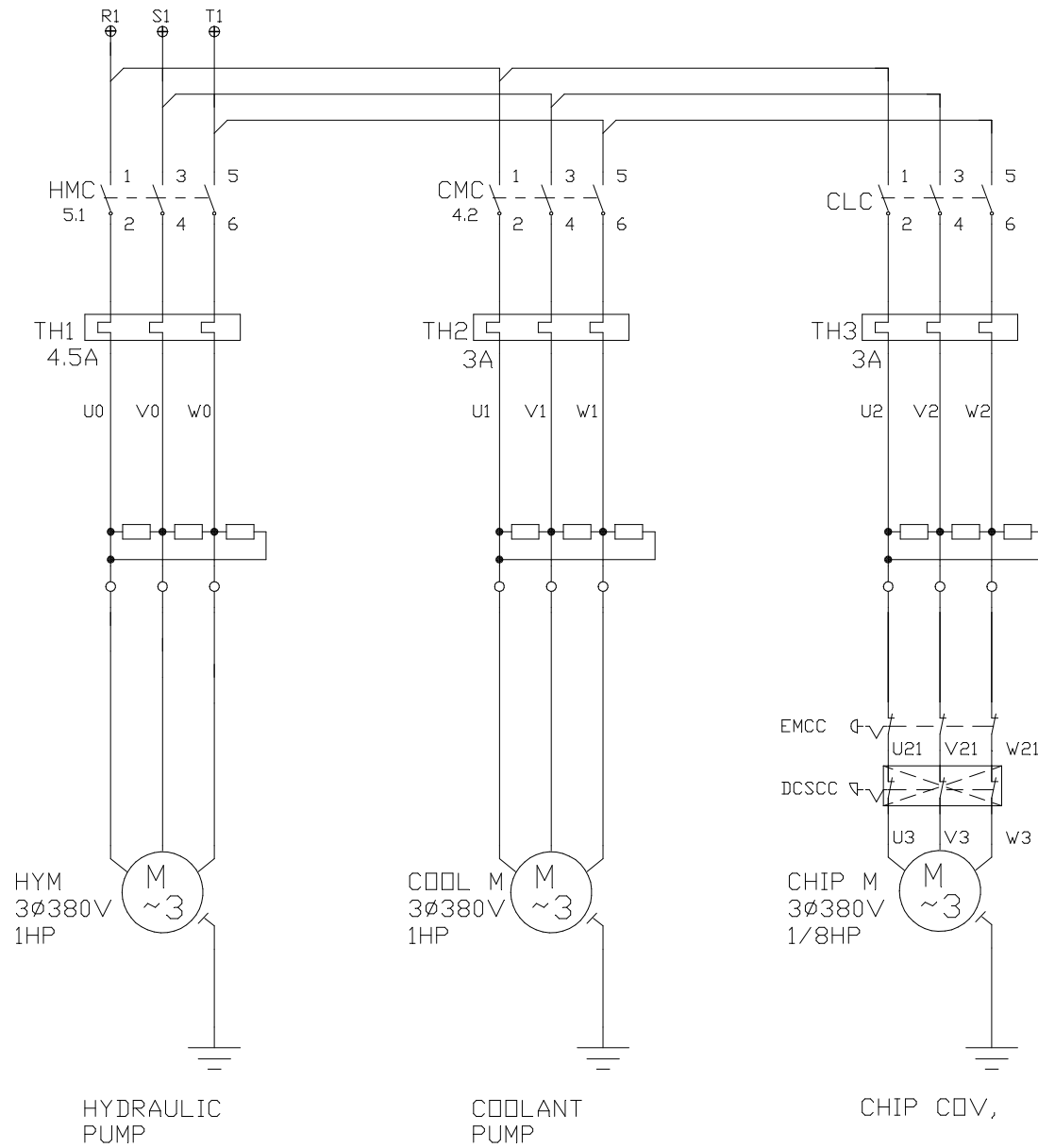

NOTE

Model	MT		
Spec.	SYNTEC		
Design		Date	
Draw	JH	Date	20200501
Check		Date	

 光鉛企業股份有限公司 KEEN CHIEF CO., LTD.	Title	3Ø380V
	No.	MT-SYN-380-02

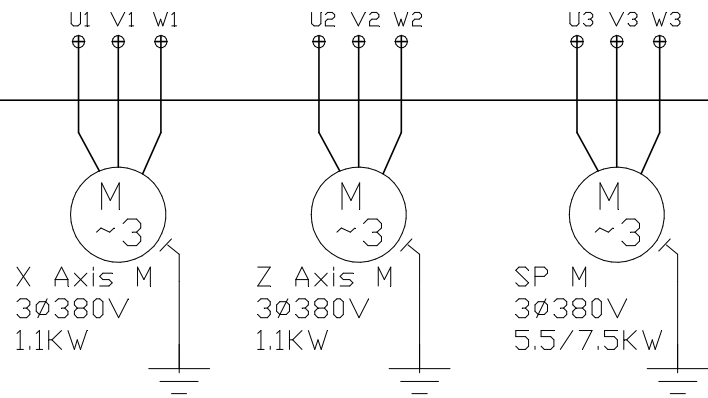
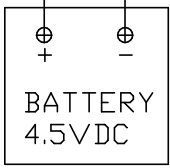
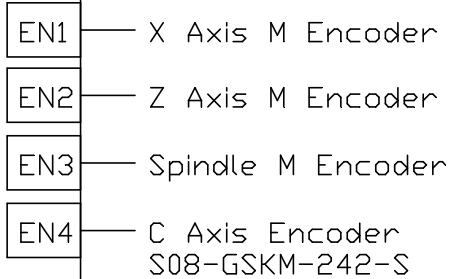
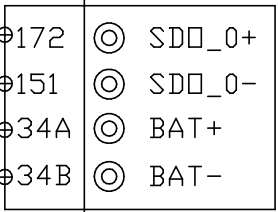
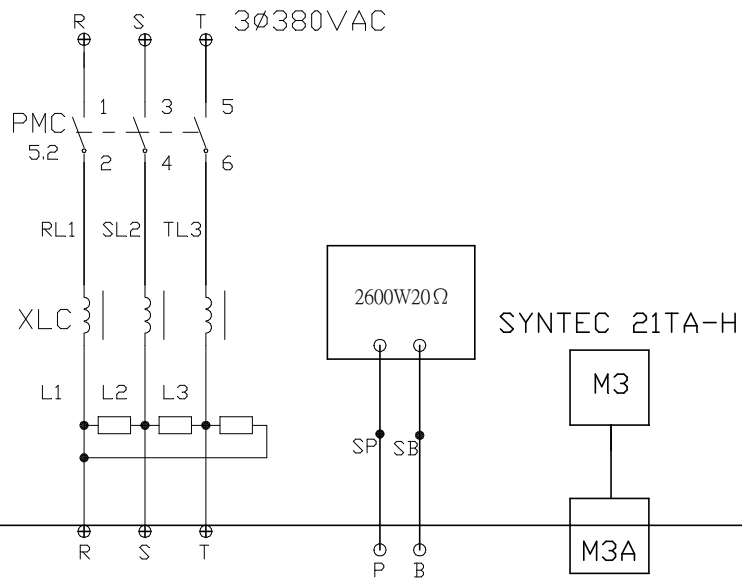
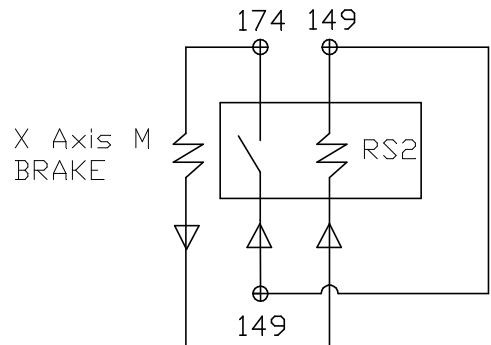

NOTE

Model	MT		
Spec.	SYNTEC		
Design		Date	
Draw	JH	Date	20200501
Check		Date	

光鉛企業股份有限公司
KEEN CHIEF CO., LTD.

Title	S08-SMD-33B
No.	MT-SYN-380-02-1

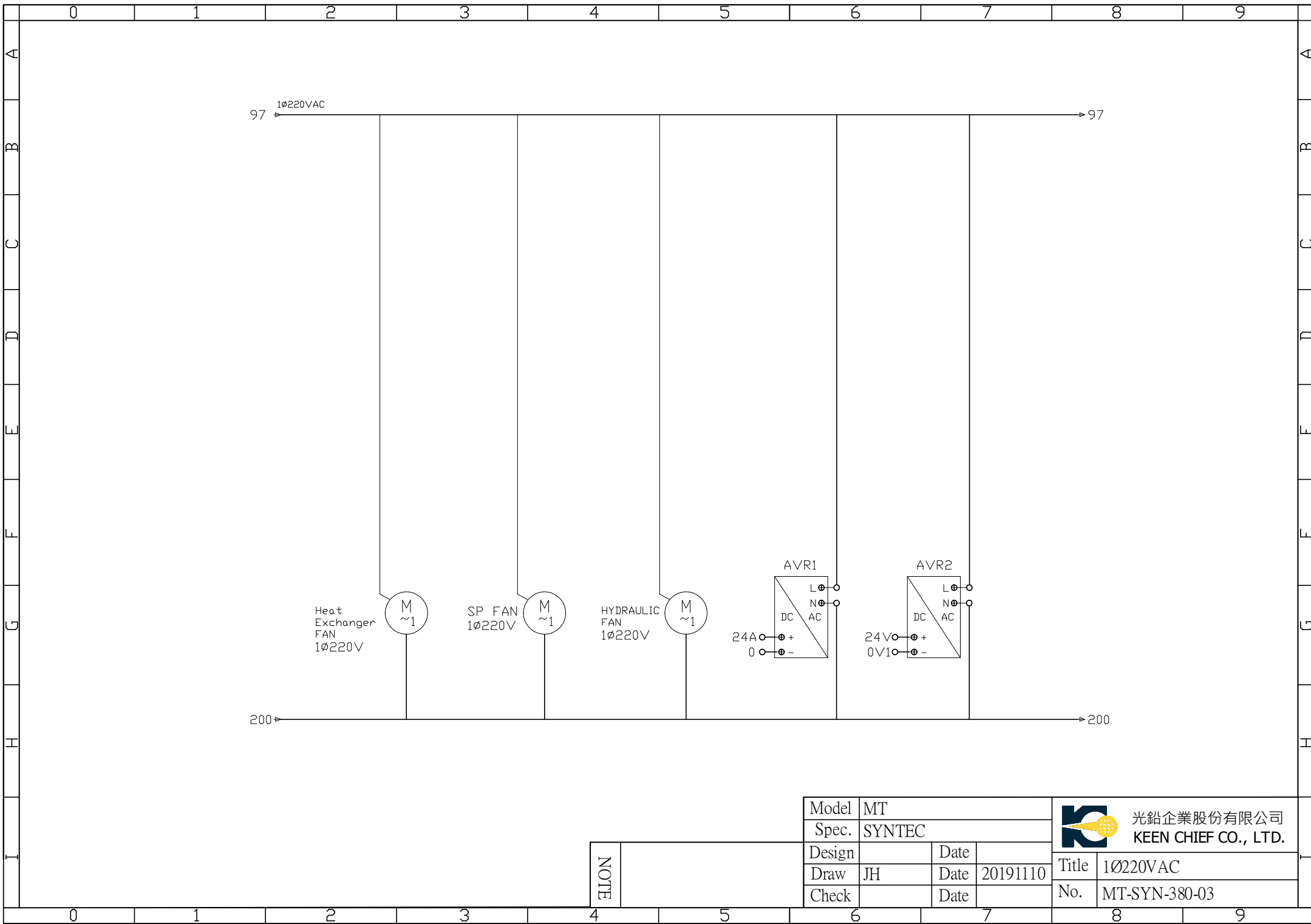

NOTE

Model	MT		
Spec.	SYNTEC		
Design		Date	
Draw	JH	Date	20191110
Check		Date	



光鉛企業股份有限公司
KEEN CHIEF CO., LTD.

Title	1Ø220VAC		
No.	MT-SYN-380-03		

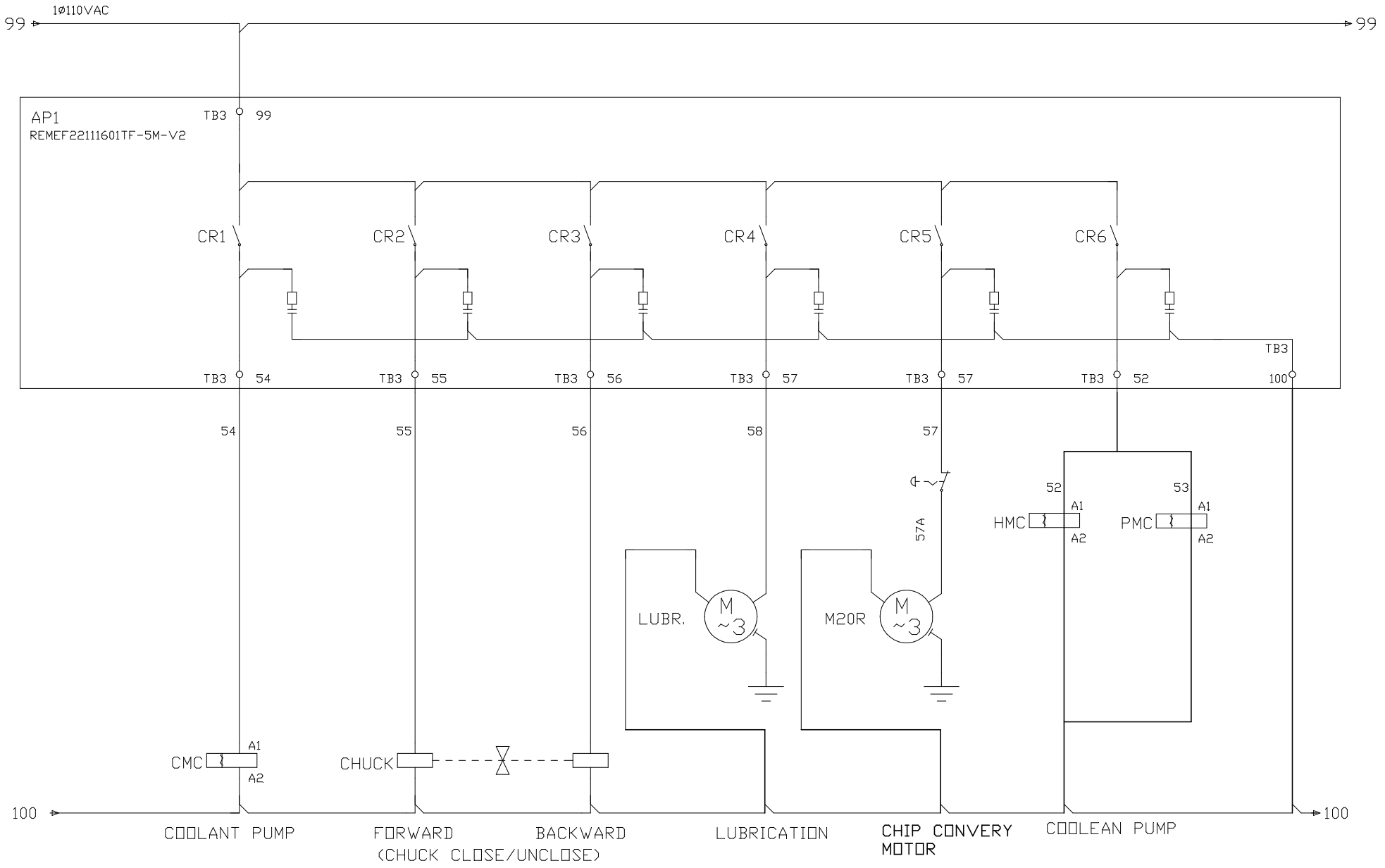

COOLANT PUMP

FORWARD
BACKWARD
(CHUCK CLOSE/UNCLOSE)

LUBRICATION

CHIP CONVEY
MOTOR

COOLEAN PUMP

NOTE

Model	MT		
Spec.	SYNTEC		
Design		Date	
Draw	JH	Date	20200501
Check		Date	

 光鉛企業股份有限公司 KEEN CHIEF CO., LTD.	Title	1Ø110VAC
	No.	MT-SYN-380-04

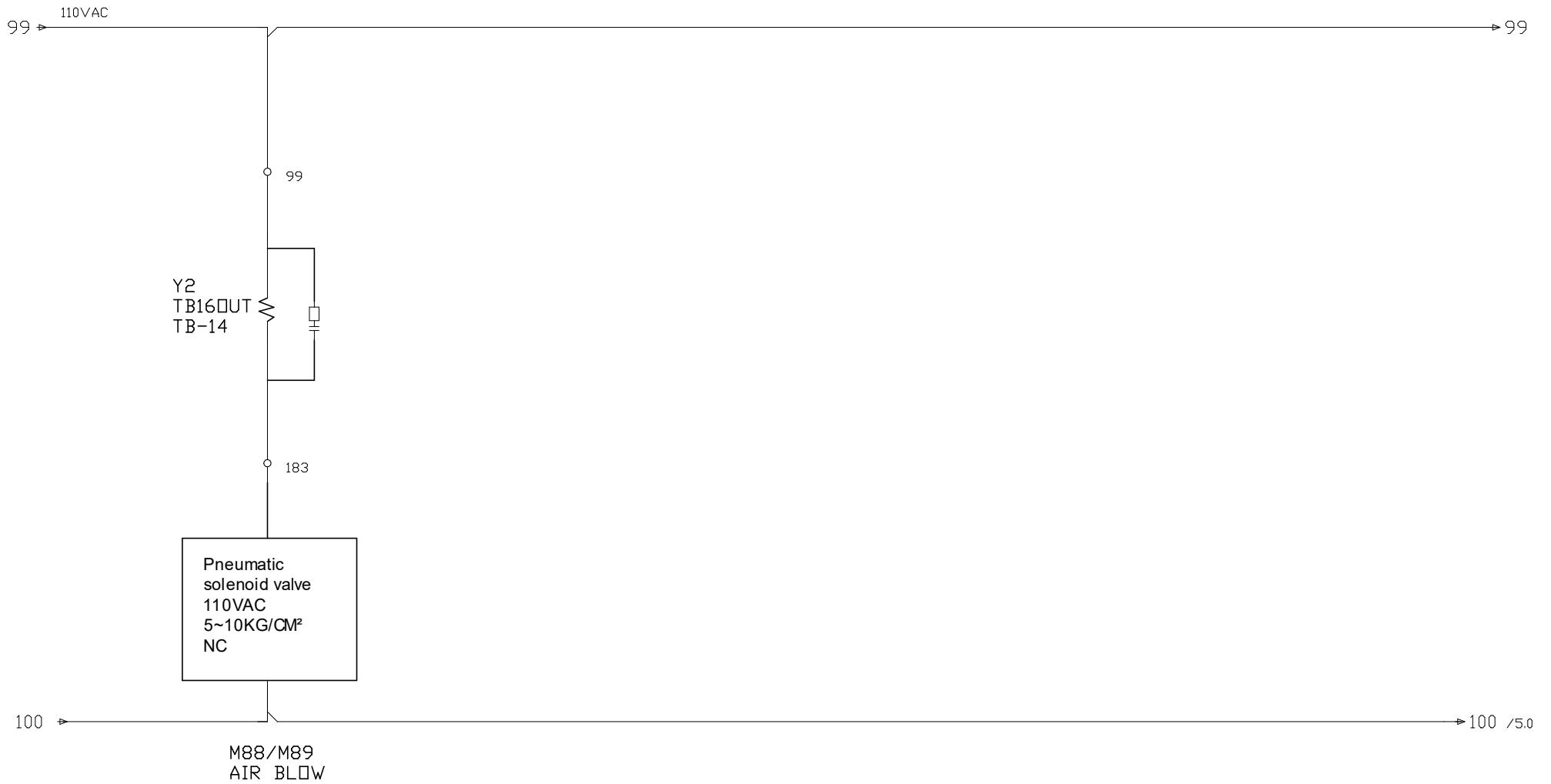

NOTE

Model	MT		
Spec.	SYNTEC		
Design		Date	
Draw	JH	Date	20200501
Check		Date	



光鉛企業股份有限公司
KEEN CHIEF CO., LTD.

Title	1Ø110VAC
No.	MT-SYN-380-04-01

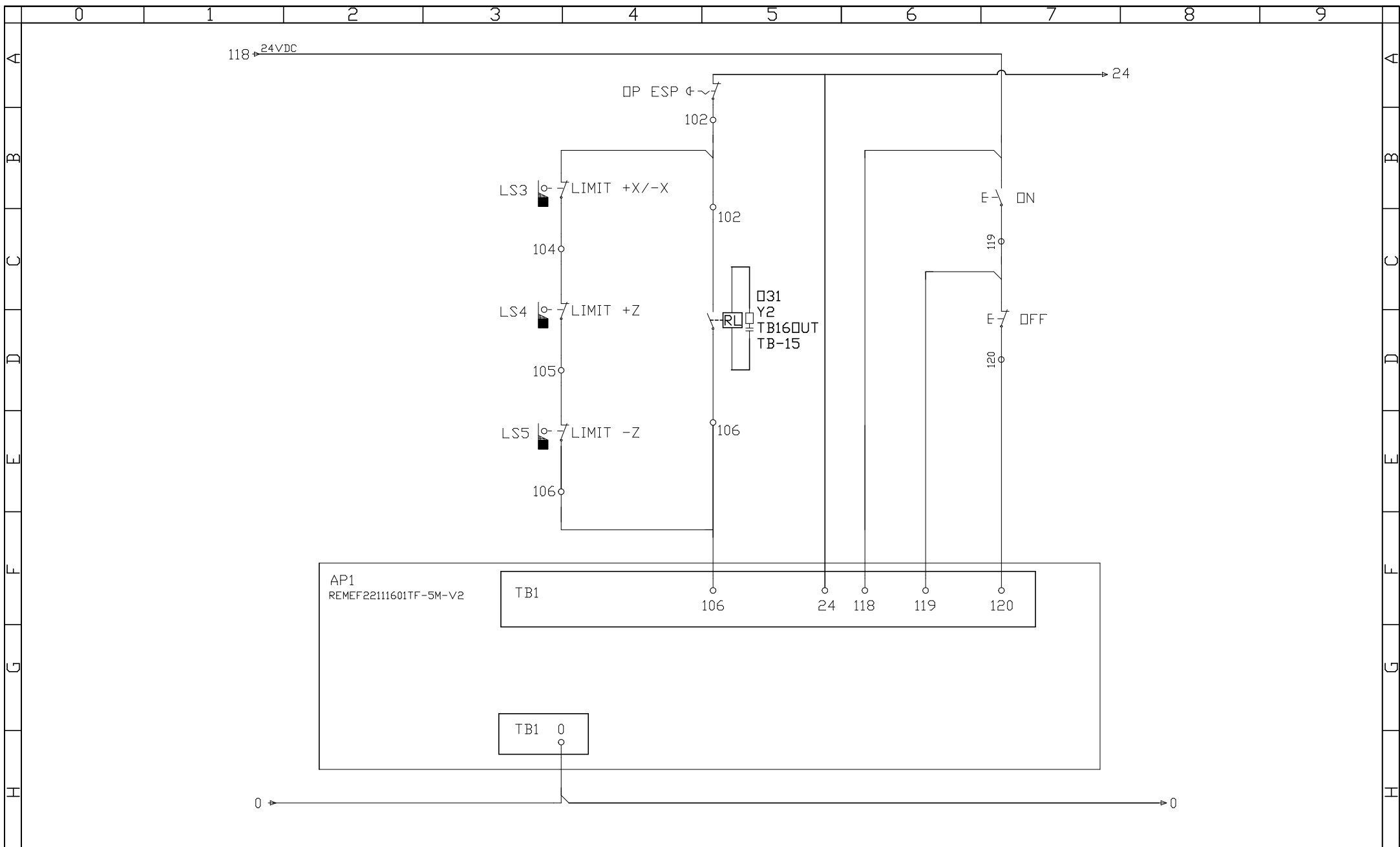

NOTE

Model	MT		
Spec.	SYNTEC		
Design		Date	
Draw	JH	Date	20200501
Check		Date	



光鉛企業股份有限公司
KEEN CHIEF CO., LTD.

Title	24VDC (24/0)
No.	MT-SYN-380-05

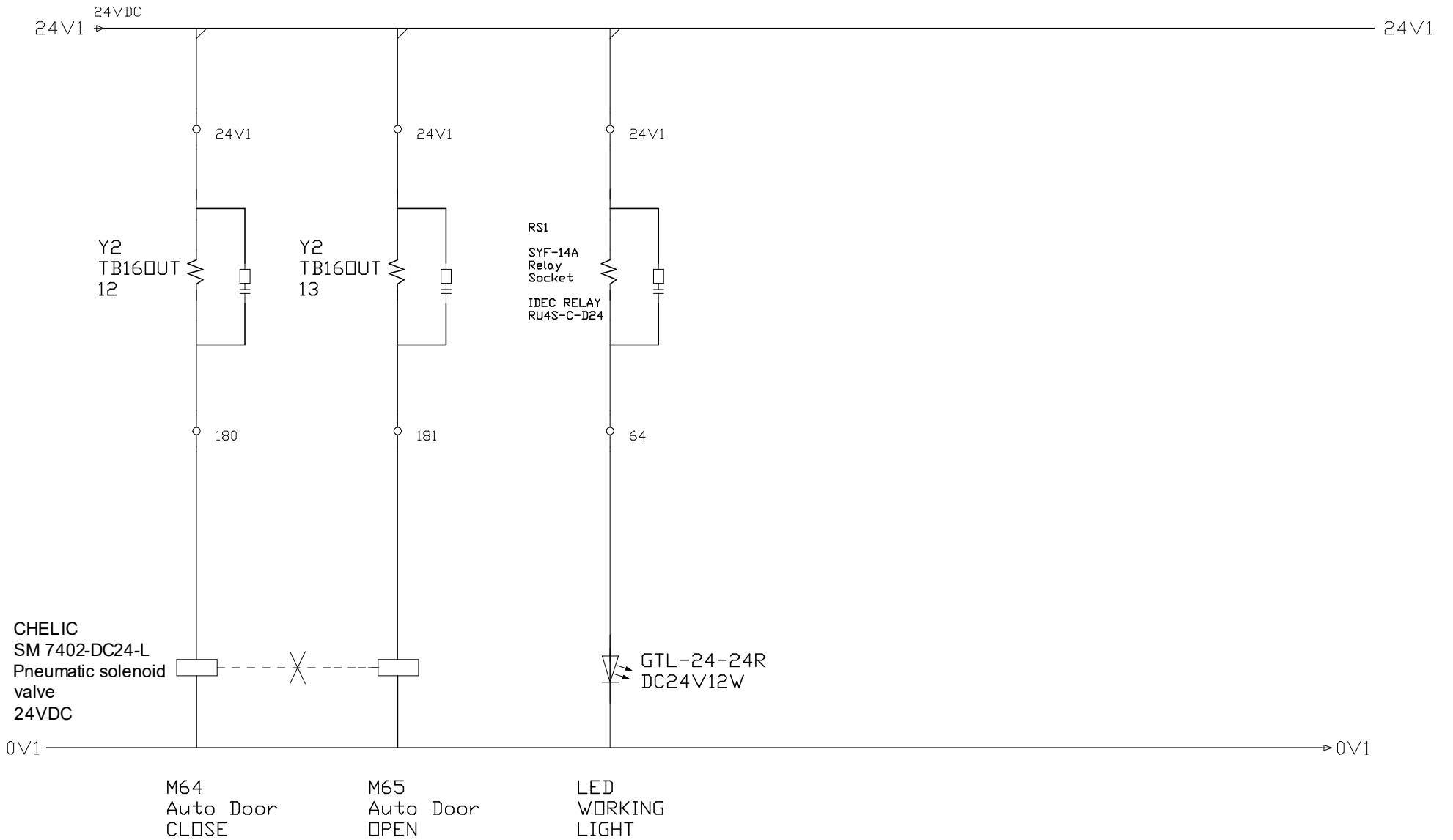

NOTE

Model	MT		
Spec.	SYNTEC		
Design		Date	
Draw	JH	Date	20200501
Check		Date	



Title	24VDC (24V1/0V1)
No.	MT-SYN-380-05-01

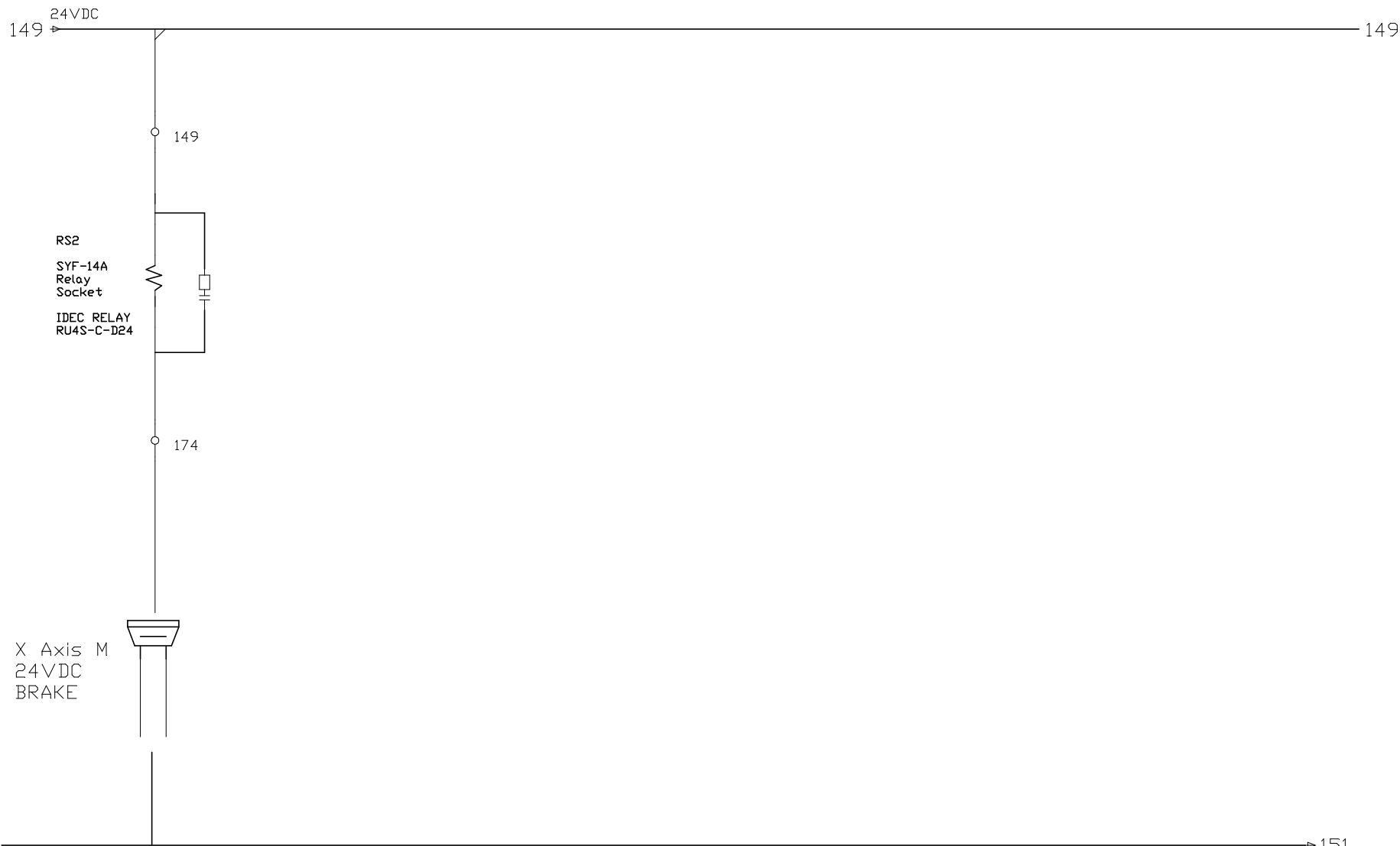

X AXIS BRAKE
24VDC

NOTE

Model	MT		
Spec.	SYNTEC		
Design		Date	
Draw		Date	20200501
Check		Date	



光鉛企業股份有限公司
KEEN CHIEF CO., LTD.

Title	24VDC (149/151)
No.	MT-SYN-380-05-02

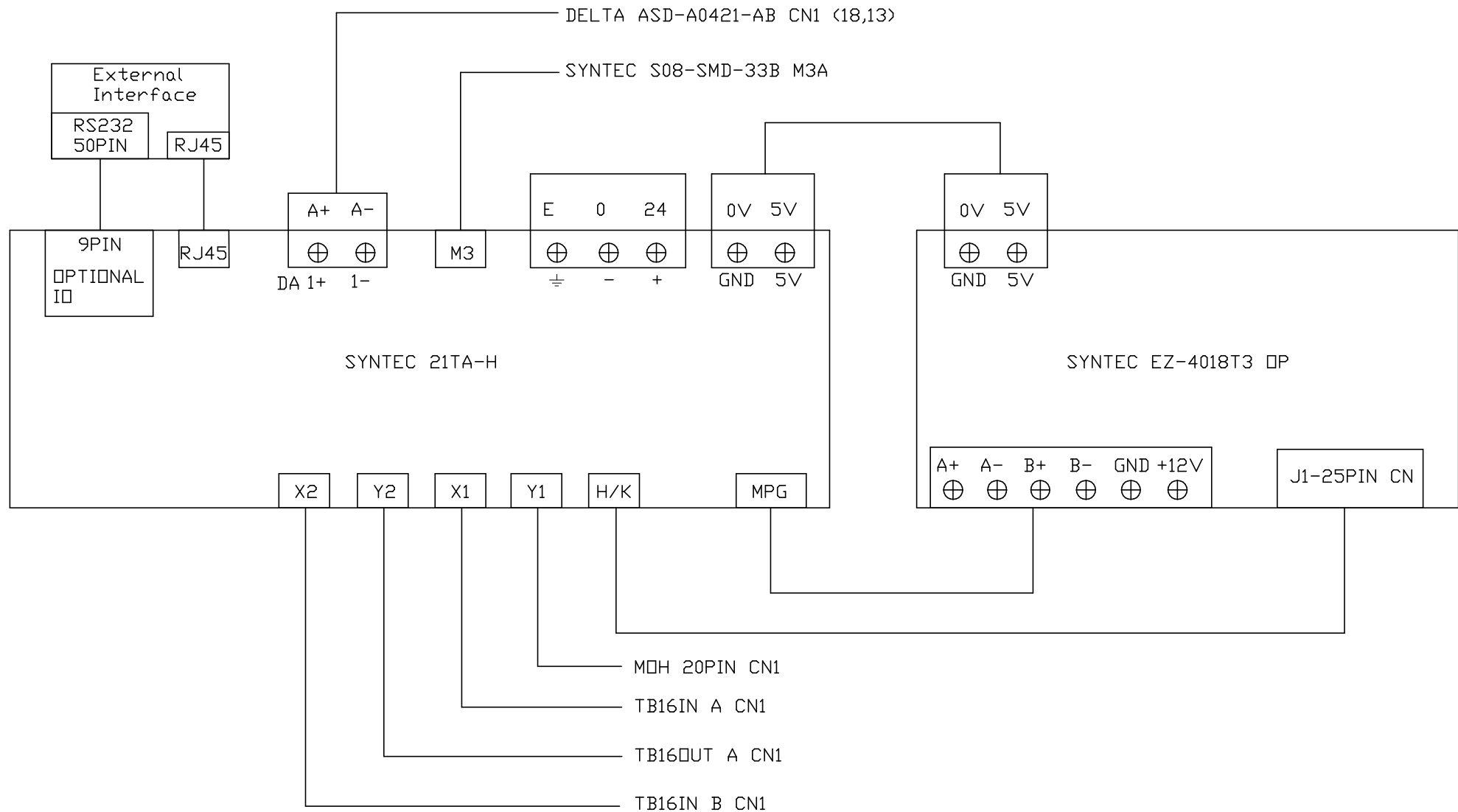

NOTE

Model	MT		
Spec.	SYNTEC		
Design		Date	
Draw	JH	Date	20191124
Check		Date	



光鉛企業股份有限公司
KEEN CHIEF CO., LTD.

Title	Controller & OP		
No.	MT-SYN-380-06		

24 PIN INTERFACE

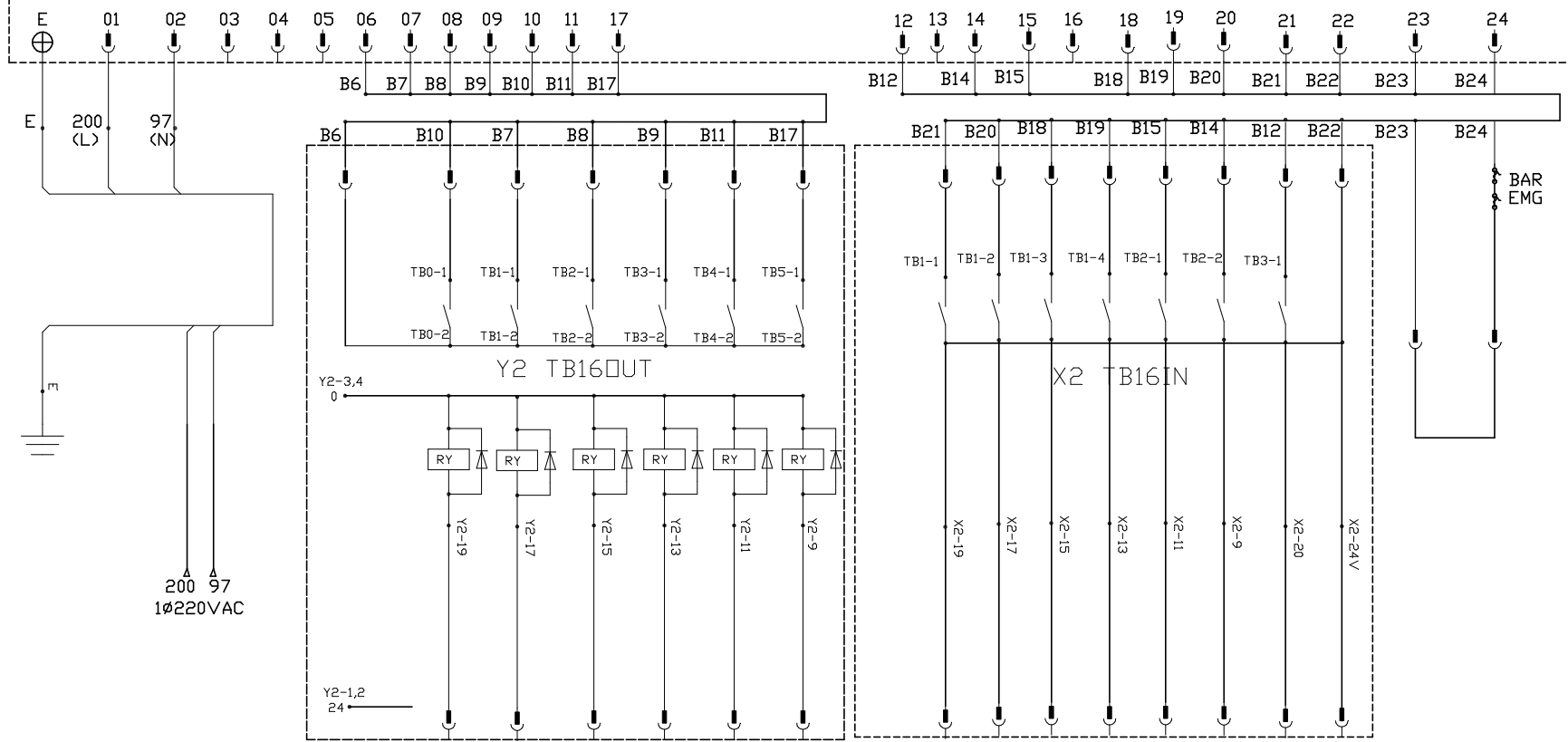

- 21 Barloader: Not Used
- 20 Barloader: CNC Auto Mode
- 19 Barloader: CNC Alarm
- 18 Barloader: M31 Barfeeder Start
- 17 Barloader: SP. CHUCK UNCLAMP READY
- 16 Barloader: M94 Back start
- 24 CDM+
- 24 X2-24V
- 20 Barloader: Hold
- 21 Barloader: In Work
- 20 Barloader: Auto Mode
- 19 Barloader: Inch Mode
- 18 Barloader: Alarm
- 17 Barloader: End
- 16 Barloader: Start

NOTE
1. Add B22 pin

Model	MT		
Spec.	SYNTEC		
Design		Date	
Draw	JH	Date	20200527
Check		Date	

 光鉛企業股份有限公司 KEEN CHIEF CO., LTD.	Title	24 PIN-Barloader Interface
	No.	MT-SYN-380-07

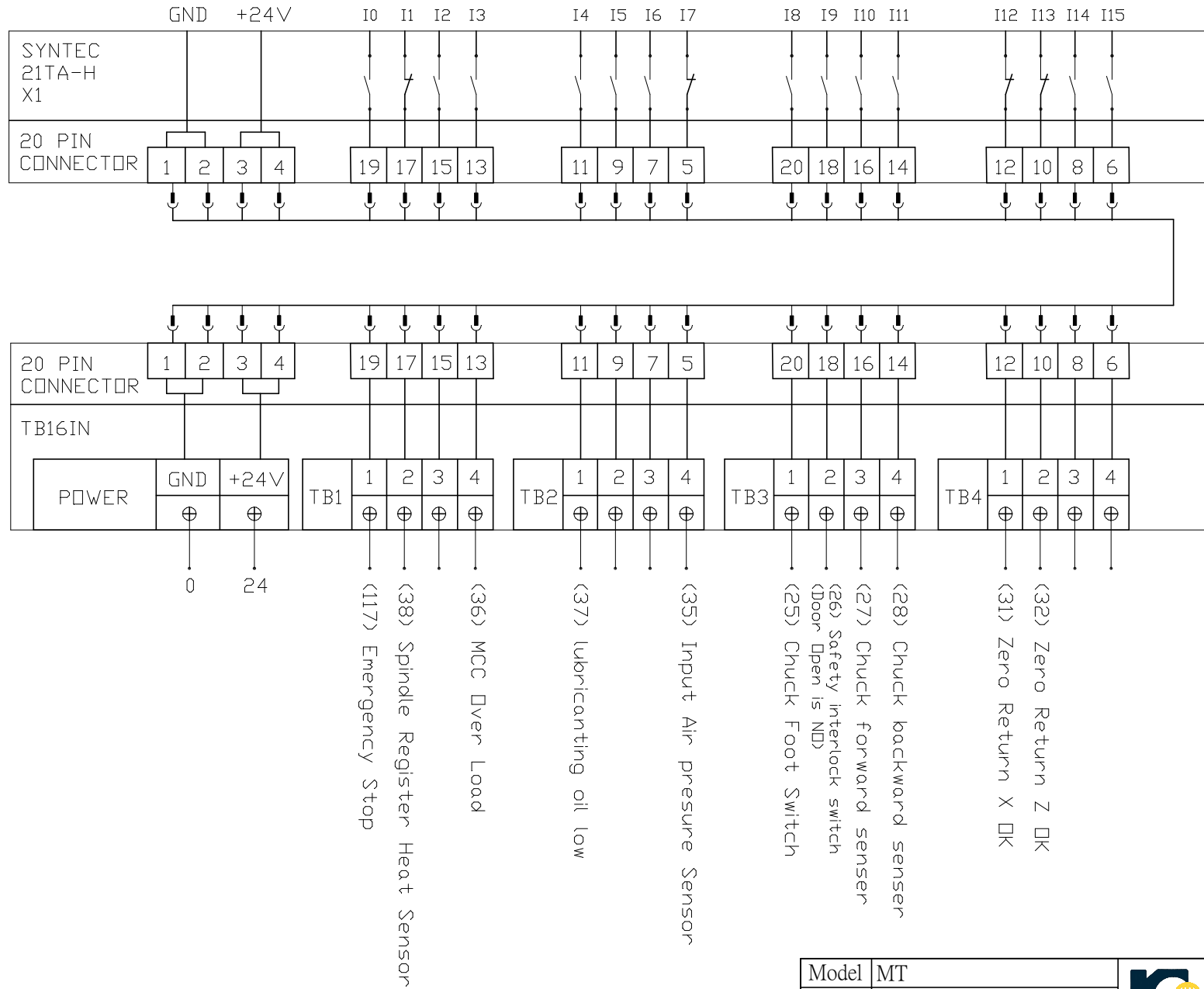

NOTE
1. I9 Add more info.

Model	MT		
Spec.	SYNTEC		
Design		Date	
Draw	JH	Date	20200527
Check		Date	



光鉛企業股份有限公司
KEEN CHIEF CO., LTD.

Title	INPUT - X1
No.	MT-SYN-380-08

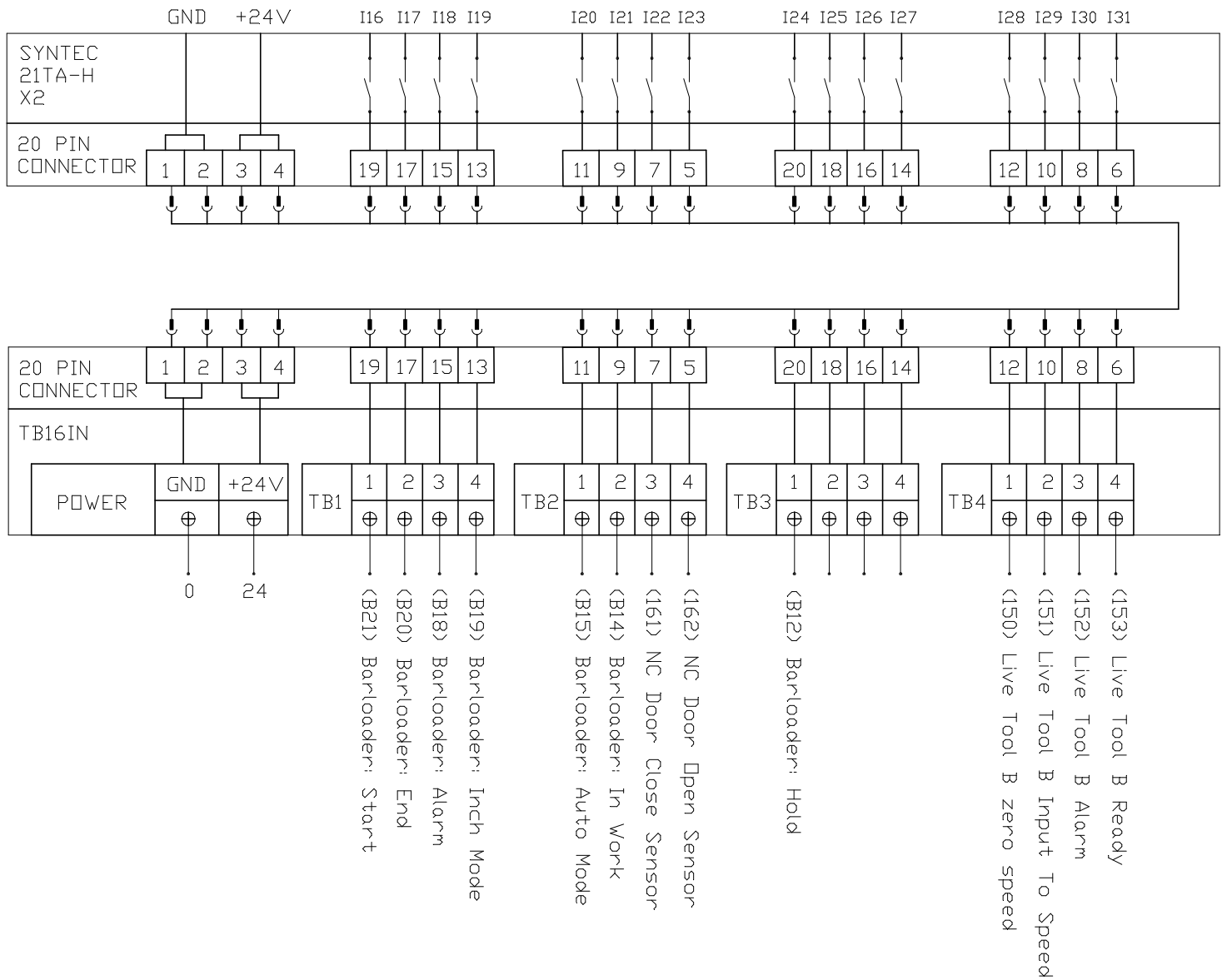

NOTE

Model	MT		
Spec.	SYNTEC		
Design		Date	
Draw	JH	Date	20200501
Check		Date	



光鉛企業股份有限公司
KEEN CHIEF CO., LTD.

Title	INPUT - X2
No.	MT-SYN-380-08-1

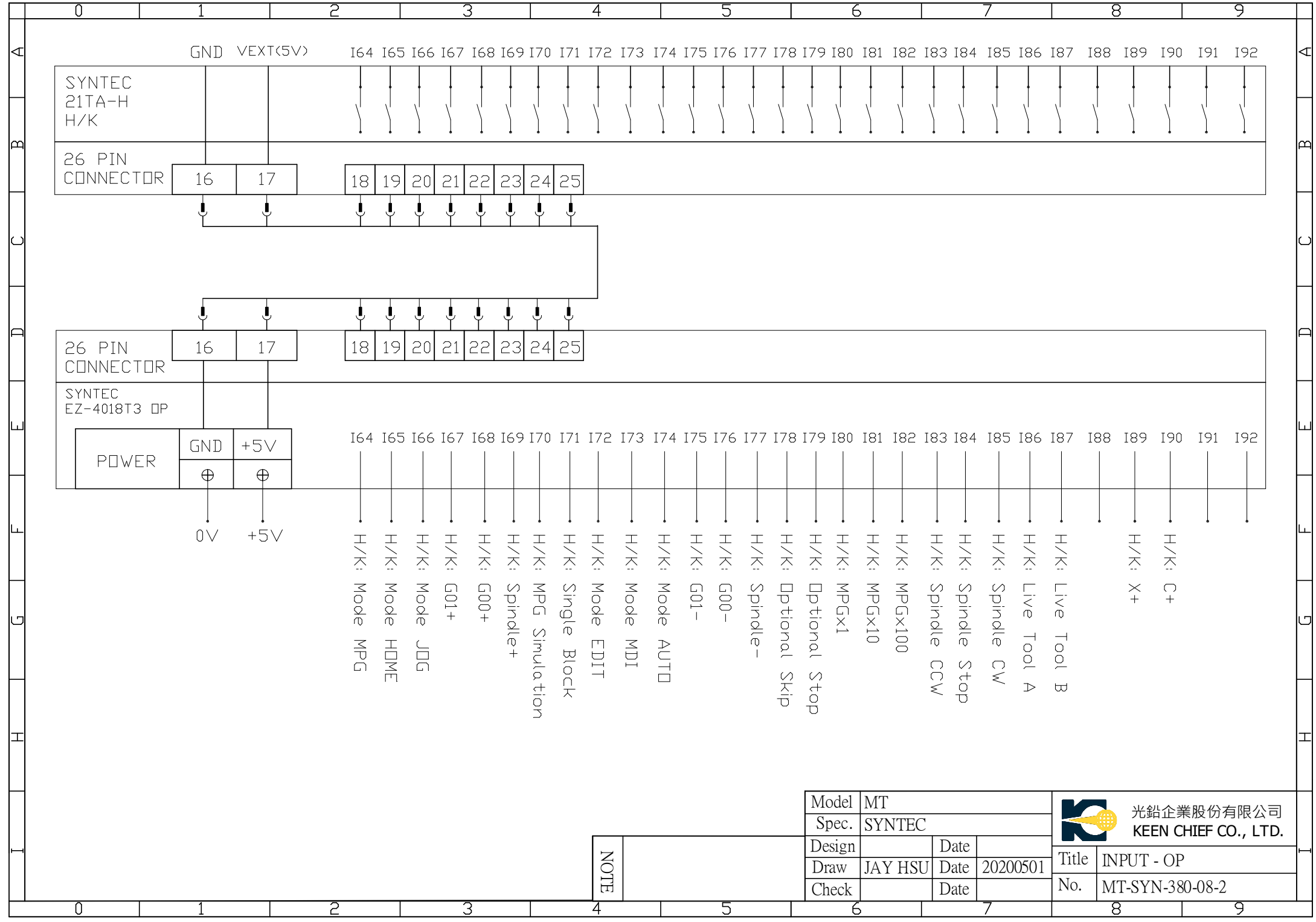

NOTE

Model	MT		
Spec.	SYNTEC		
Design		Date	
Draw	JAY HSU	Date	20200501
Check		Date	



光鉛企業股份有限公司
KEEN CHIEF CO., LTD.

Title	INPUT - OP		
No.	MT-SYN-380-08-2		

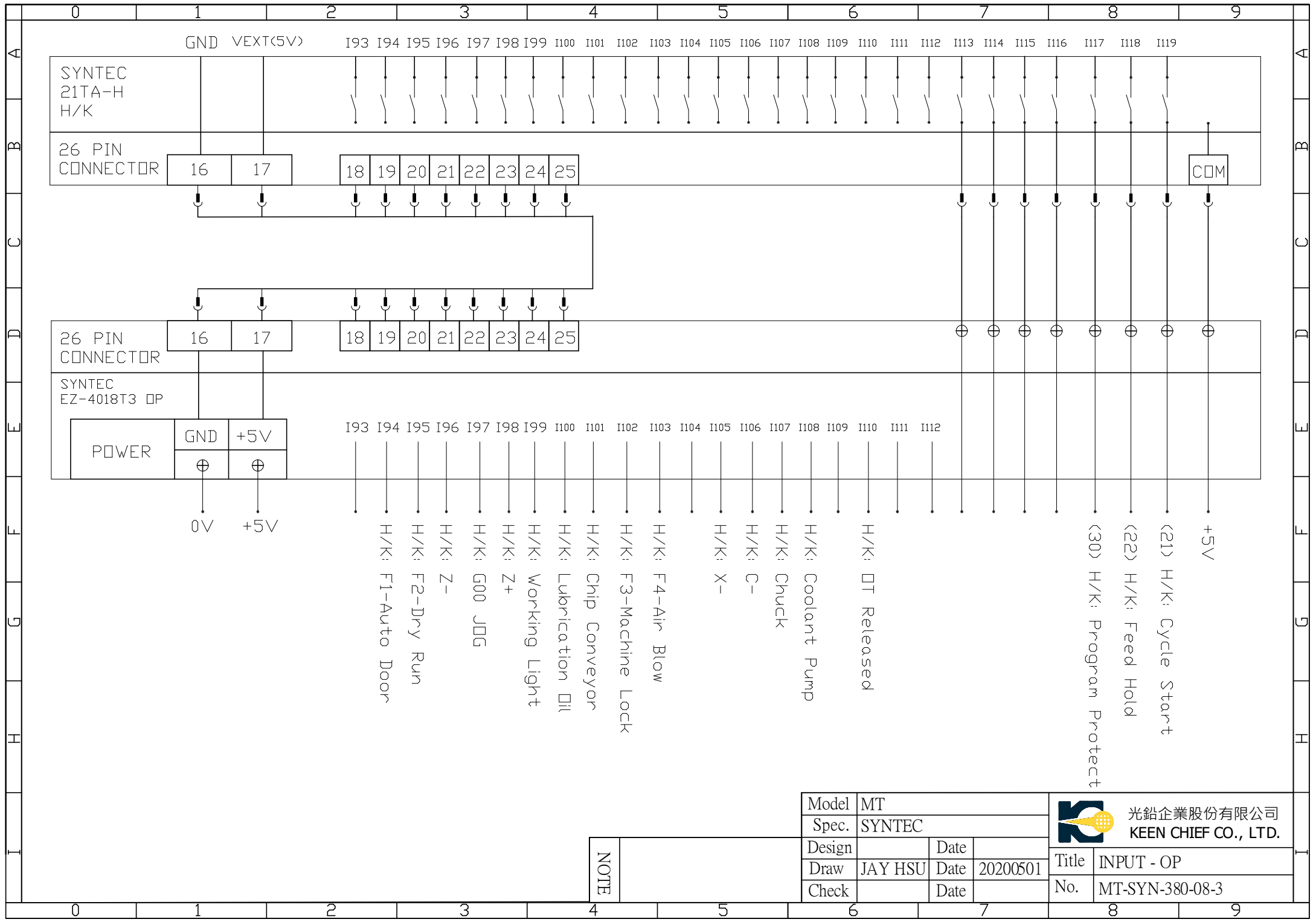

Model	MT		
Spec.	SYNTEC		
Design		Date	
Draw	JAY HSU	Date	20200501
Check		Date	



光鉛企業股份有限公司
KEEN CHIEF CO., LTD.

Title	INPUT - OP
No.	MT-SYN-380-08-3

NOTE

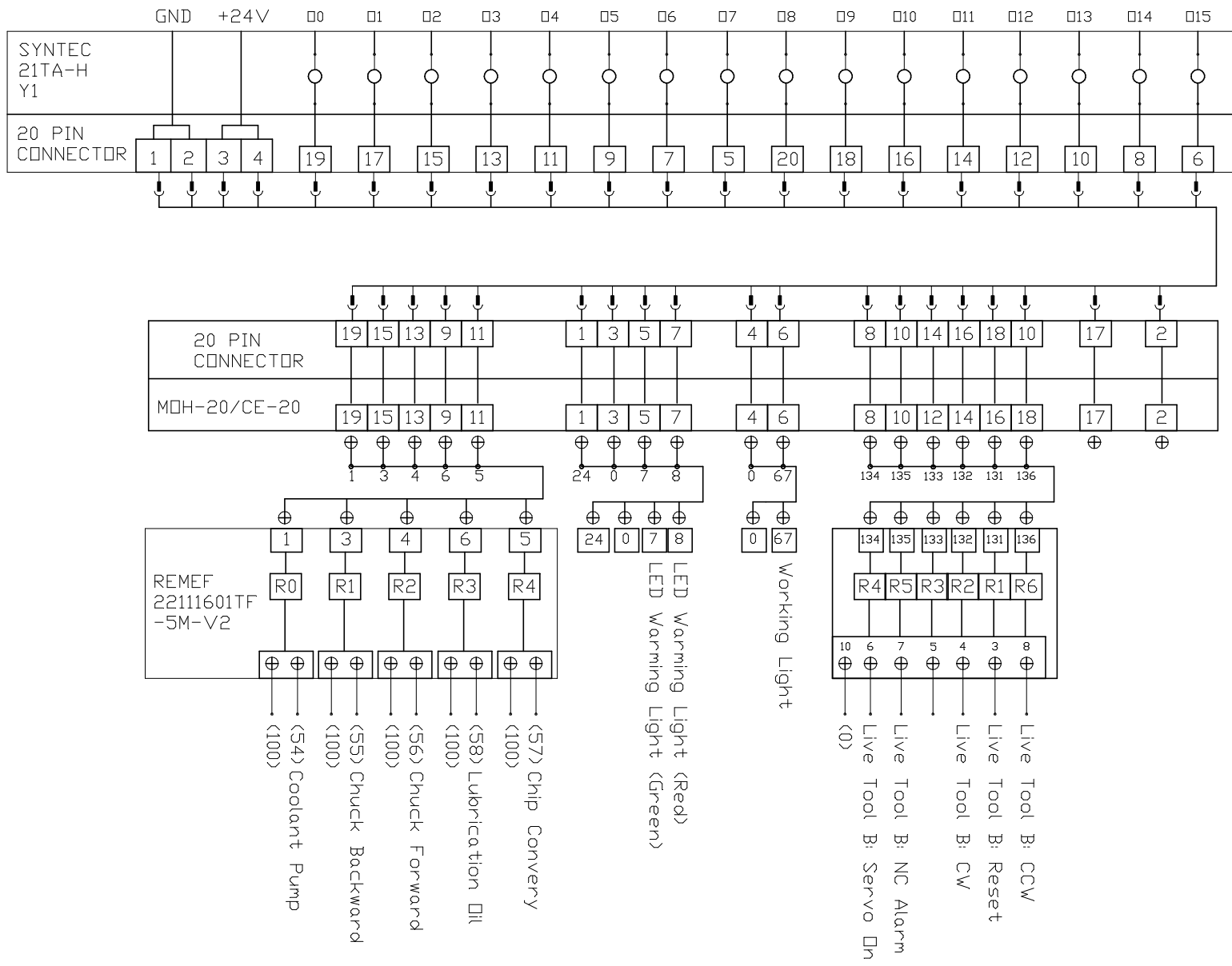

NOTE

Model	MT		
Spec.	SYNTEC		
Design		Date	
Draw	JAY HSU	Date	20200501
Check		Date	



光鉛企業股份有限公司
KEEN CHIEF CO., LTD.

Title	OUTPUT - Y1
No.	MT-SYN-380-09

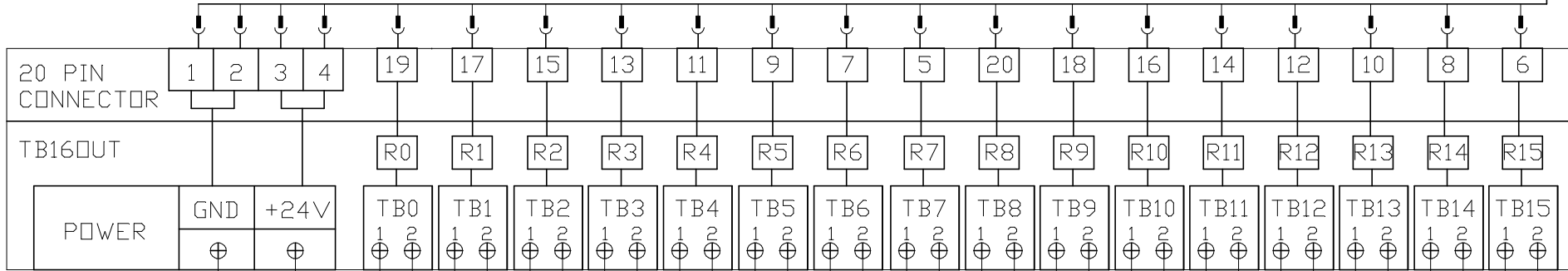
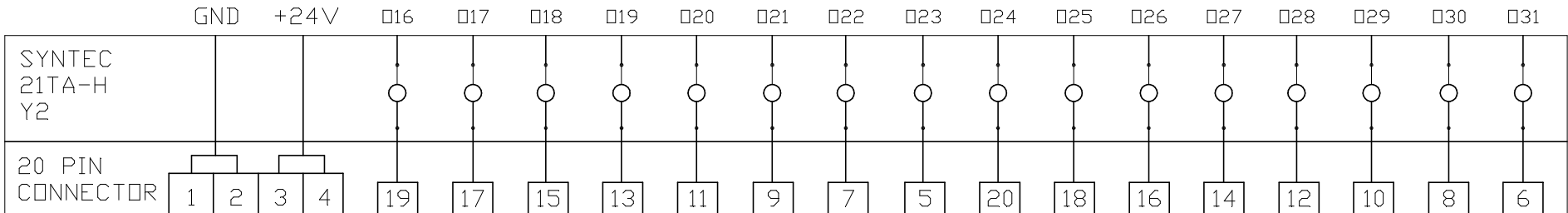

0 24

(B6) Barloaders: M94 Back

(B6) Barloaders: SP, CHUCK

(B7) UNCLAMP READY

(B8) Barloaders: M31 Barfeeder Start

(B6) Barloaders: CNC Alarm

(B6) Barloaders: CNC AUTO MODE

(B6) Barloaders: NDT USED

(102) DT Released

(106)

(99) Air Blow

(183)

(24V1) Door Open

(24V1) Door Close

(180)

NOTE

Model	MT		
Spec.	SYNTEC		
Design		Date	
Draw	JAY HSU	Date	20200501
Check		Date	



光鉛企業股份有限公司
KEEN CHIEF CO., LTD.

Title	OUTPUT-Y2
No.	MT-SYN-380-09-1

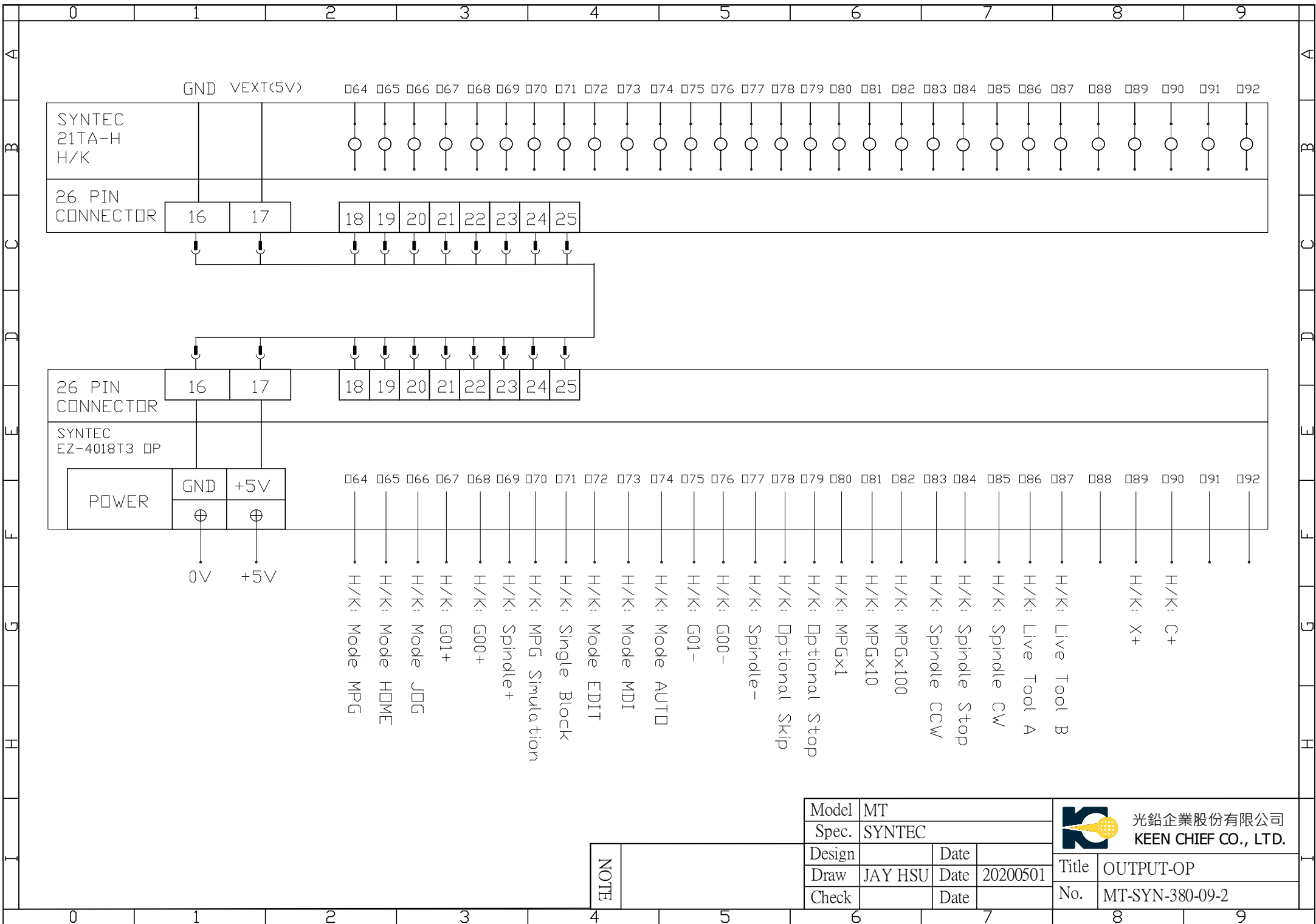

Model	MT		
Spec.	SYNTEC		
Design		Date	
Draw	JAY HSU	Date	20200501
Check		Date	

 光鉛企業股份有限公司 KEEN CHIEF CO., LTD.	Title	OUTPUT-OP
	No.	MT-SYN-380-09-2

NOTE

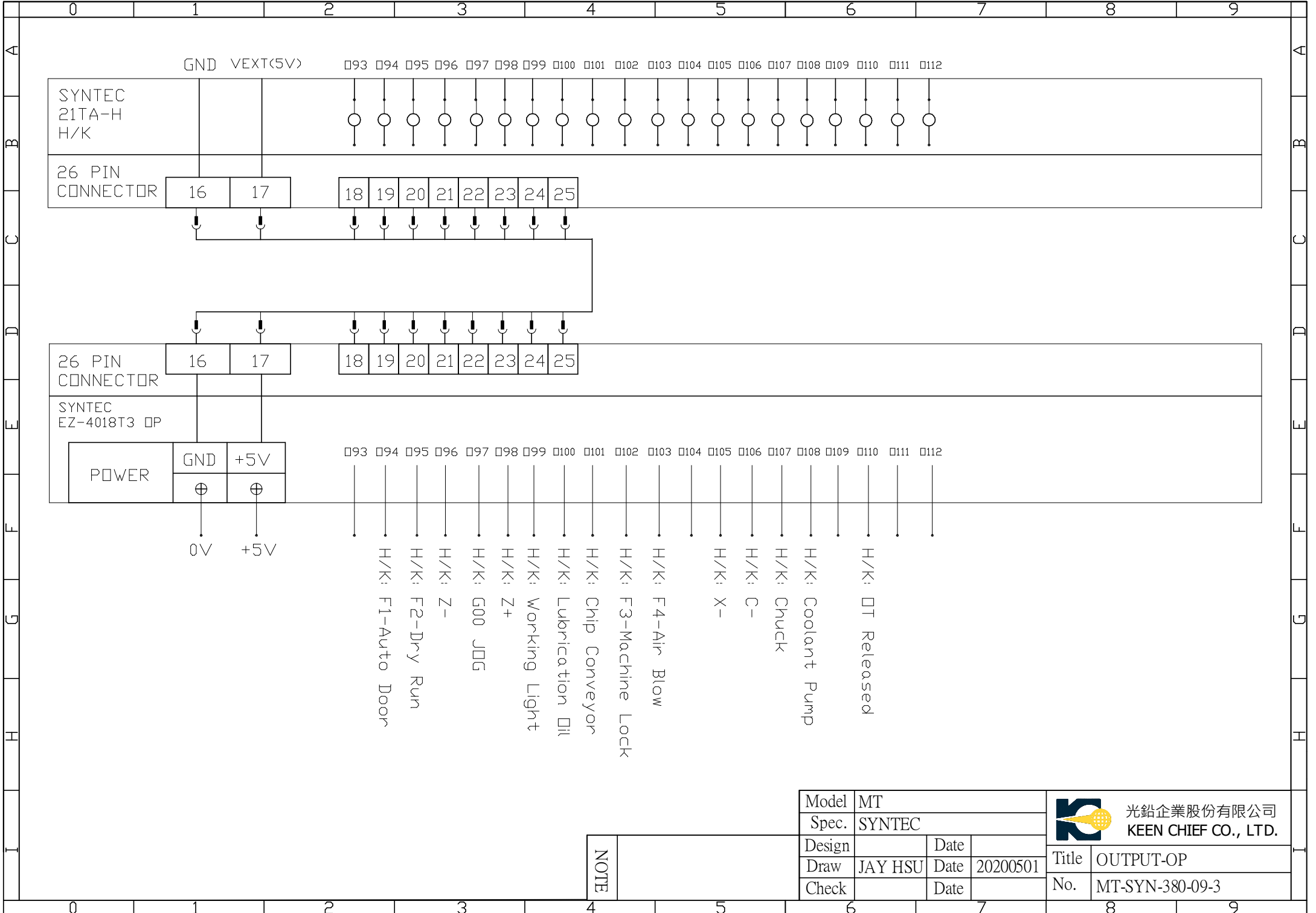

NOTE

Model	MT		
Spec.	SYNTEC		
Design		Date	
Draw	JAY HSU	Date	20200501
Check		Date	



光鉛企業股份有限公司
KEEN CHIEF CO., LTD.

Title	OUTPUT-OP
No.	MT-SYN-380-09-3

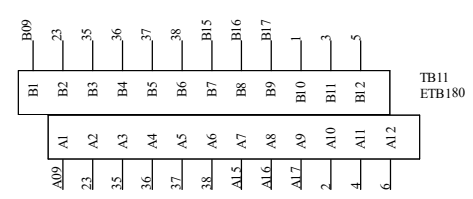
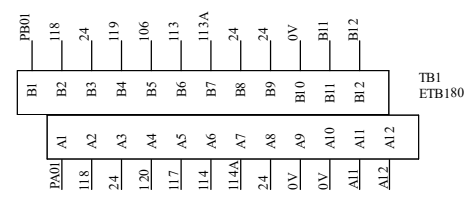
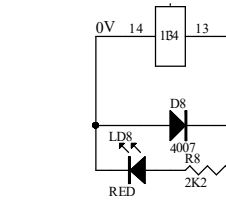
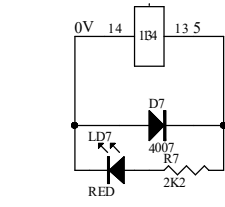
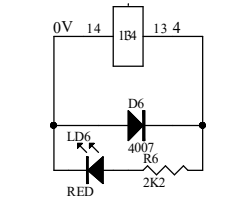
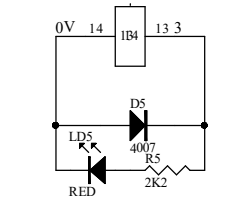
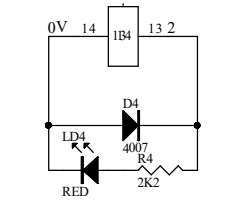
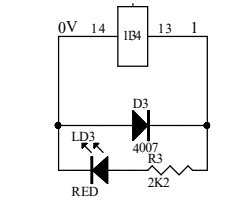
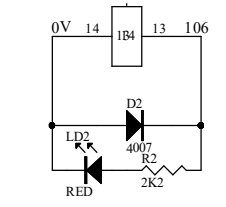
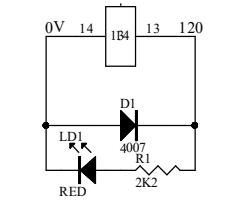
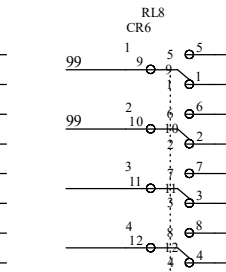
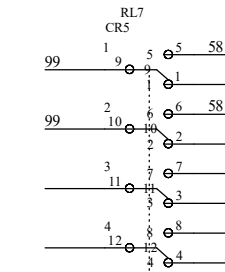
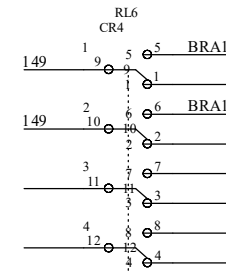
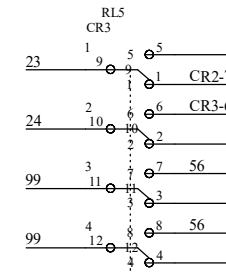
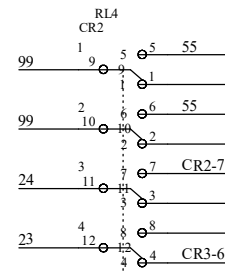
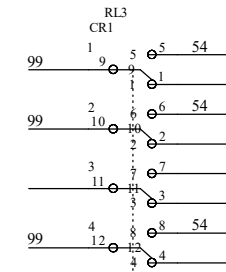
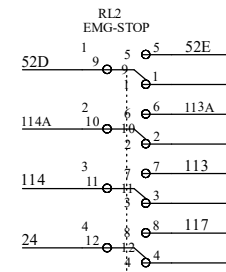
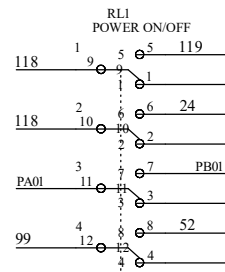
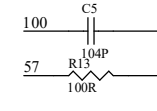
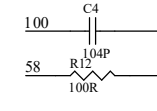
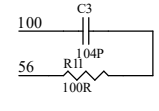
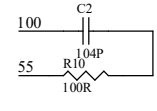
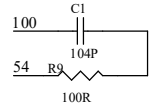
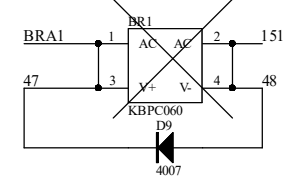
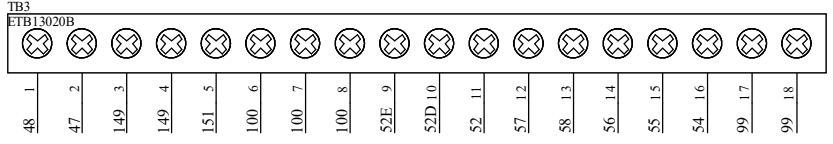

NOTE

Model	MT		
Spec.	SYNTEC		
Design		Date	
Draw	JH	Date	20200501
Check		Date	

光鉛企業股份有限公司
KEEN CHIEF CO., LTD.

Title	REMEF22111601TF-5M-V2
No.	MT-SYN-380-AP-1

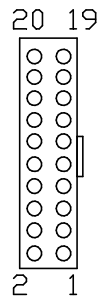

Y1 CONNECTION

PIN	SIGNAL
1	24VDC
2	24VDC
3	GND
4	GND
5	□7
6	□15
7	□6
8	□14
9	□5
10	□13
11	□4
12	□12
13	□3
14	□11
15	□2
16	□10
17	□1
18	□9
19	□0
20	□8

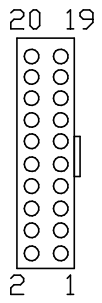

Y2 CONNECTION

PIN	SIGNAL
1	24VDC
2	24VDC
3	GND
4	GND
5	□23
6	□31
7	□22
8	□30
9	□21
10	□29
11	□20
12	□28
13	□19
14	□27
15	□18
16	□26
17	□17
18	□25
19	□16
20	□24

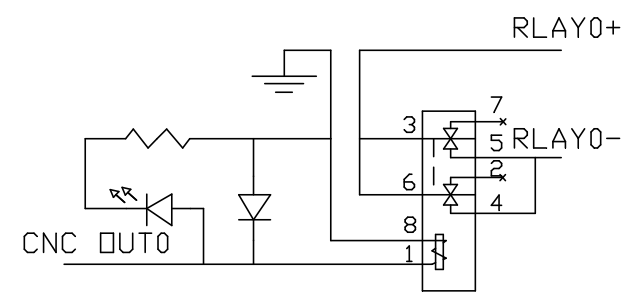

NOTE

Model	MT		
Spec.	SYNTEC		
Design		Date	
Draw	JH	Date	20200501
Check		Date	

光鉛企業股份有限公司
KEEN CHIEF CO., LTD.

Title	SYNTEC TB-16-OUT
No.	MT-SYN-380-AP-2

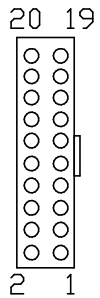

X1 CONNECTION

PIN	SIGNAL
1	24VDC
2	24VDC
3	GND
4	GND
5	I7
6	I15
7	I6
8	I14
9	I5
10	I13
11	I4
12	I12
13	I3
14	I11
15	I2
16	I10
17	I1
18	I9
19	I0
20	I8

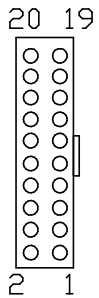

X2 CONNECTION

PIN	SIGNAL
1	24VDC
2	24VDC
3	GND
4	GND
5	I23
6	I31
7	I22
8	I30
9	I21
10	I29
11	I20
12	I28
13	I19
14	I27
15	I18
16	I26
17	I17
18	I25
19	I16
20	I24

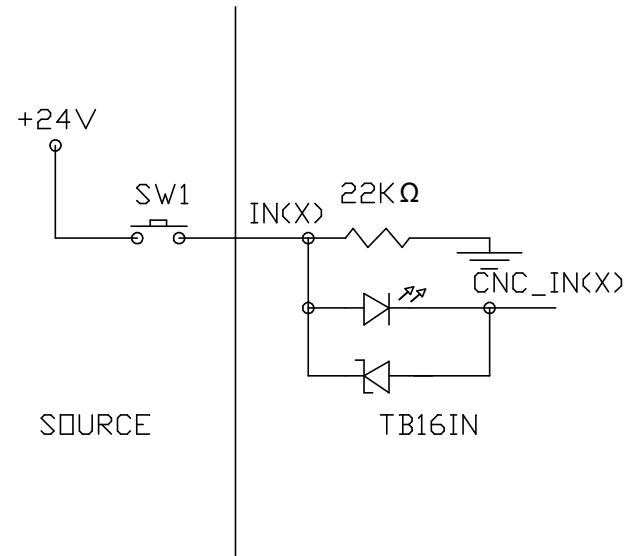

NOTE

Model	MT		
Spec.	SYNTEC		
Design		Date	
Draw	JH	Date	20200501
Check		Date	



光鉛企業股份有限公司
KEEN CHIEF CO., LTD.

Title	SYNTEC TB-16-IN
No.	MT-SYN-380-AP-3

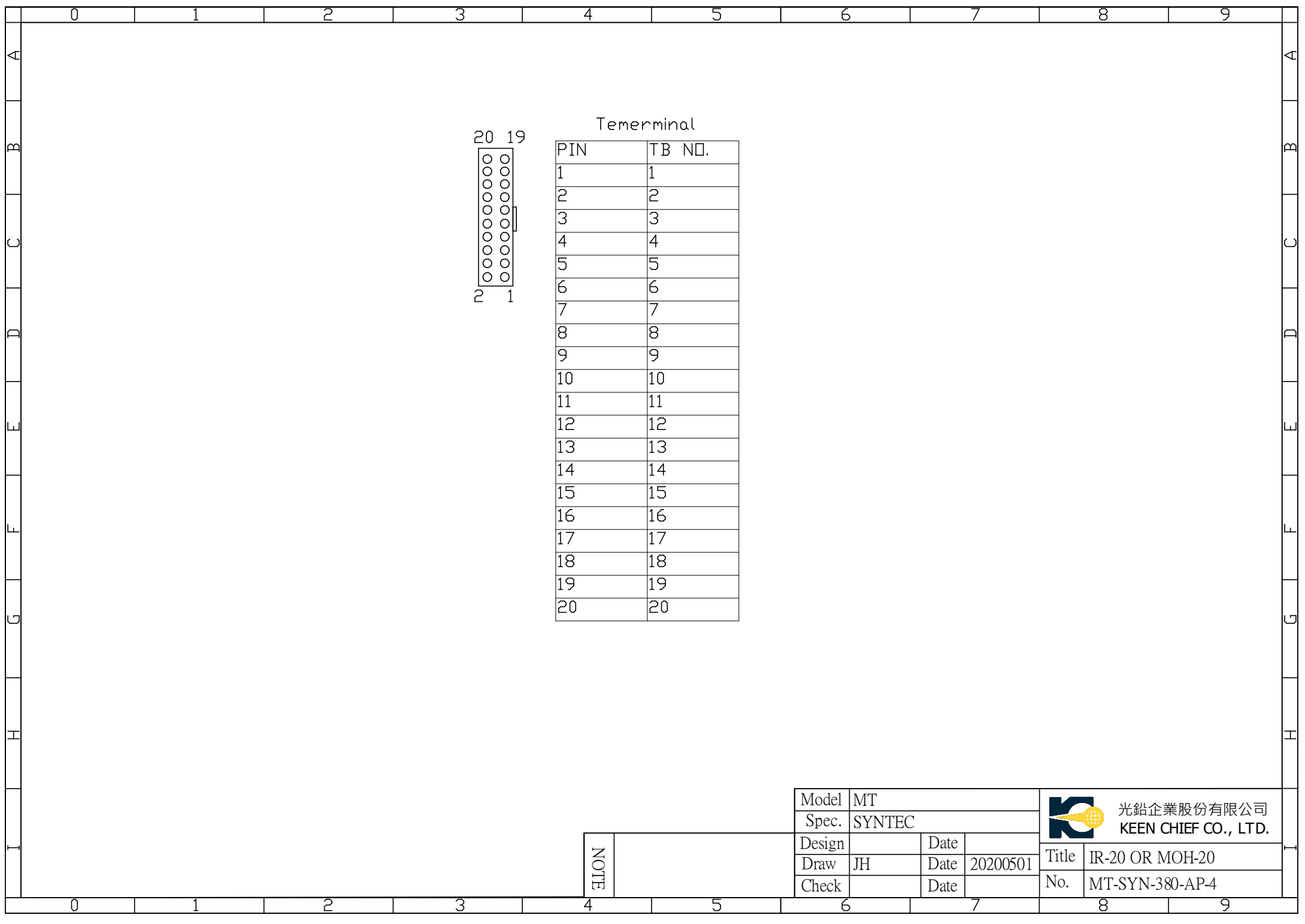

Terminal

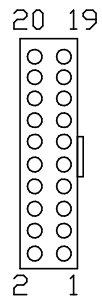

PIN	TB NO.
1	1
2	2
3	3
4	4
5	5
6	6
7	7
8	8
9	9
10	10
11	11
12	12
13	13
14	14
15	15
16	16
17	17
18	18
19	19
20	20

NOTE

Model	MT		
Spec.	SYNTEC		
Design		Date	
Draw	JH	Date	20200501
Check		Date	

 光鉛企業股份有限公司 KEEN CHIEF CO., LTD.	Title	IR-20 OR MOH-20
	No.	MT-SYN-380-AP-4